

EOS JUNIOR

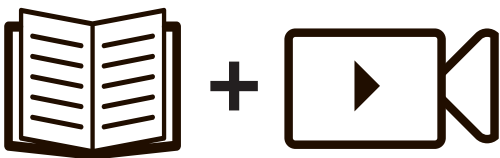

Version 2021_2



<https://janssens-alusystems.be/downloads>



HANDLEIDING

MOUNTING INSTRUCTIONS

INSTRUCTIONS DE MONTAGE

AUFBAUANLEITUNG

MONTAGE-VEJEDNING

MONTERINGSVEILEDNINGEN

ISTRUZIONI DI MONTAGGIO

Produktinformatie

Geachte klant,

U heeft met de aanschaf van de JUNIOR aluminium serre een juiste keuze gemaakt waarmee wij u veel plezier wensen.

Opmerkingen

Deze handleiding is vooreerst opgesteld voor alle standaardconstructies maar bevat voldoende aanwijzingen om een vlotte montage van andere uitvoeringen te garanderen. De zwarte rubber strips zijn aan de binnenkant met olie behandeld. Dit garandeert een eenvoudige en snelle montage. Bovenaan het gootprofiel is een inbrengdetail voorzien maar hier dient GEEN rubber gemonteerd te worden. Mogelijke zwarte plekken op de profielen zijn eenvoudig met een aluminiumreinigingsmiddel af te nemen, het betreft geen productiefouten. Voor het plaatsen van een fundering in beton, dient de grond vorstvrij te zijn. Het dak van de serre moet in de winter van sneeuw bevrijd worden, of op een gepaste manier ondersteund worden. De serre moet op een van de wind afgeschermd plaats opgebouwd worden. Tijdens de montage dient men gepaste beschermende kledij te dragen (b.v. veiligheidshandschoenen) om kwetsuren te vermijden. Men dient steeds de lokaal gebruikelijke bouwverordeningen in acht te nemen.

Volgorde van de montage

Opbouw en montage volgorde is voor alle JUNIOR modellen hetzelfde.

- Uitsorteren van aluminium profielen volgens modelgrootte.
- Montage en opbouw van gehele constructie
- Horizontaal en waterpas stellen van de constructie.
- Beglazing

Benodigd gereedschap

Schroefsleutel Nr. 10, schroevendraaijer, waterpas, boorapparaat en boortje Ø4.2, metaalzaag, werkhandschoenen, schaar (voor het snijden van rubber).

Konstruktiewijzigingen onder voorbehoud.

Product Information

Dear customer,

Thank you for buying a high-quality aluminium greenhouse model JUNIOR.

Remarks

In all drawings you find the mounting-instructions for all basic standard-models. However this manual should be a sufficient guidance for all special-case greenhouses. The aluminium profiles may show black stains, these stains are not a production error. They can be easily removed with a aluminium cleaner available at every good drugstore. The rubber profiles have been treated with oil on the interior to facilitate the assembly. The ground must be frost-free in order to place a concrete foundation. During winter the roof has to be cleared of snow or supported in a suitable way. The greenhouse should be built in a location protected from strong winds. Protective gear (such as protective gloves) should be used during construction in order to avoid injuries. One should at all times pay attention to the local building regulations.

Assembly order

The assembly procedure is the same for all JUNIOR greenhouses.

- Sorting of the profiles according the model.
- Mounting of the complete aluminium construction.
- Levelling of the construction using a water-level.
- Glazing.

Required tools

Socket wrench nr. 10 or spanner nr. 10, water-level, screwdriver, drilling machine + drill 4.2 mm, scissors (to cut the rubber)

We reserve the right to change the construction without prior notice!

Information sur le produit

Cher client,

Nous vous félicitons à l'achat de la serre en aluminium, modèle JUNIOR.

Remarques

Dans ce manuel vous trouvez les instructions de montage pour tous les modèles standards d' Arcadia. Par contre, ce manuel est aussi un bon guide pour tous les modèles spéciaux. Les couvercles noirs en caoutchouc sont, à l'intérieur, traités à l'huile. Ceci garantit un montage simple et rapide. Si les profilés en alu montrent des taches noires, il ne s'agit pas d'un défaut de production. Ces taches peuvent facilement être enlevées au moyen de nettoyeurs pour aluminium, qui sont disponible sur le marché. Le coulage d'une fondation en béton ne peut pas être mis à exécution quand il gèle. Pendant l'hiver il faut enlever la neige de la toiture ou étançonner le toit. Il faut construire la serre dans un endroit protégé du vent. Afin d'éviter des blessures lors de la montage, il faut porter des vêtements de travail, qui pourront vous protéger (p.e. des gants de sécurité) On doit de tout temps respecter les règles urbanistiques locales.

Déroulement du montage

L'ordre de montage est identique pour tous les modèles JUNIOR :

- Triage des profilés en alu en fonction des dimensions du modèle.
- Assemblage des profilés et montage de la structure.
- Alignement vertical et horizontal de la construction.
- Pose du vitrage.

Outillage nécessaire

Clef N° 10, tournevis, niveau à bulle, perceuse et foret Ø4.2mm, scie à métaux, gants de travail, ciseaux (pour la mise à longueur du joint en caoutchouc).

Sous réserve de tout changement.

Produkt Information

Sehr geehrter Kunde,

Wir möchten Ihnen zum Kauf des Gewächshauses Modell JUNIOR gratulieren.

Bemerkungen

Die Aufbauanleitung bezieht sich zunächst auf das Standardmodell „Arcadia“. Für die Sonderkonstruktionen gibt es zusätzliche Hinweise zur Montage. Das Gewächshaus soll in einer windgeschützten Lage montiert werden. Im Winter muss das Dach von Schnee befreit oder durch geeignete Maßnahmen abgestützt werden. Alle Konstruktionen sind nach baurechtlichen Vorschriften am Boden zu befestigen. Unlackierte Alu-Profile können schwarze Flecken aufweisen. Hierbei handelt es sich nicht um einen Produktionsfehler. Durch handelsüblichen Alu-Reiniger lassen sich diese entfernen. Das mitgelieferte Dichtungsgummi ist an der Innenseite mit Talg behandelt, was zu einer schnelleren und einfacheren Montage beiträgt. Bei der Montage muss man Schutzausrüstung tragen z.B. Sicherheitshandschuhe, um Verletzungen zu vermeiden.

Montageablauf

Der Montagevorgang ist bei allen JUNIOR-Modellen gleich:

- Auslegen der Alu-Profile gemäß Modellgröße.
- Aufbau der Alu-Konstruktion.
- Horizontale und vertikale Ausrichtung der Konstruktion.
- Verglasung.

Benötigtes Werkzeug

Schraubenschlüssel Nr. 10, Schraubenzieher, Wasserwaage, Bohrmaschine und Bohrer (4.2 mm) Metallsäge, Schere (für das zuschneiden der Gummidichtung).

Konstruktionänderungen sind behalten wir uns vor.

Produkt-information

Kære kunde,

Tillykke med Deres nye JUNIOR drivhus. De har valgt et højt kvalitetsprodukt, som De vil få megen fornøjelse af.

Bemærkninger:

Denne montage-vejledning er først og fremmest lavet for alle vores standard-konstruktioner, men kan også bruges til montage af specielkonstruktioner, da der er inkluderet flere supplerende anvisninger. Alle gummilister er indvendigt behandlet med olie, som sikrer en enkelt og hurtigt montage. (Pas på det kan smitte af på fliserne) .På underkanten af tagrenden er der forudset en rille, hvor der IKKE skal monteres gummilister.

Mulige sorte pletter på profilerne kan nemt fjernes med et aluminiums rengøringsmiddel – disse er ikke produktionsfejl.

Hvis De laver et fundament i beton, skal undergrunden være frostfrit.

Taget skal om vinteren så vidt muligt gøres frit for sne.

Fremgangsmåden for montagen:

Opbygning og montage er den samme for alle JUNIOR størrelser.

- Lægge alle dele frem
- Monter hele aluminiumskonstruktionen
- Sæt konstruktionen i vatter og i vinkel.
- Monter glasset

Værktøj:

Nøgle nr. 10, skruetrækker, vatterpas, boremaskine og bor Ø 4,2 mm, arbejdshandsker, saks (for at klippe gummilisterne)

Vi tar forbehold om endringer i konstruksjonen.

Produktinformasjon

Kjære kunde

Til lykke med Deres nye JUNIOR drivhus. De har valgt ett høy-kvalitetsprodukt, som vi håper De vil få meget glede av.

Bemerkninger

Denne monteringsveiledningen er først og fremst laget for alle våre standardkonstruksjoner, men kan også brukes til montering av spesialkonstruksjoner, da det er inkludert flere supplerende anvisninger.

Alle gummilistene er innvendig behandlet med olje, som sikrer en enkel og hurtig montering. (Vær obs på at oljen kan smitte av.) På underkanten av takrenden er det en rille hvor det IKKE skal monteres gummilister.

Mulige sorte pletter på profilene kan lett fjernes med ett aluminiums rengjøringsmiddel – disse er ikke produktionsfeil.

Hvis De lager ett fundament i betong skal jorda/grunnen være frostfri.

Om vinteren bør taket gjøres fritt for snø.

Drivhuset bør plasseres på et lunt sted.

De bør bruke beskyttende tøy som for eksempel hansker ved montering.

Fremgangsmåte ved montering

Oppbygging og montering er den samme for alle JUNIOR størrelser.

- Legg alle deler frem.
- Monter hele aluminiumskonstruksjonen
- Sett konstruksjonen i vater og vinkel.
- Monter glassene / isolerplastplatene.

Verktøy

Nøkkel nr. 10, skrutrekker, vater, boremaskin og bor Ø 4,2mm, metallsag, arbeidshansker, saks (for å klippe gummilistene).

Vi tar forbehold om endringer i konstruksjonen.

Produktinformation för montage av JUNIOR växthus

Bästa kund.

Tack för att Ni köpt ett JUNIOR växthus av aluminium med hög kvalitet.

På de följande sidorna hittar ni monteringsanvisningar för de varierande Arcadia modellerna samt skisser på de olika profilerna.

För de hus som inte är lackerade (ren aluminium) kan det ibland finnas mörkare fläckar vilket är naturligt. Dessa kan med lätthet tvättas bort med en aluminiumrengörare som kan köpas i färghandeln.

Gummiprofilerna har blivit behandlade med olja för att underlätta vid montering. Grundarbetet måste vara utfört på sådant sätt att marken inte rör sig vid tjäle samt att huset bör vara förankrat genom fastgjutning.

Vid snöfall under vintern bör snön tas ned från taket. Vid rikligt snöfall bör huset gärna stöttas i mitten på nocken speciellt om Ni inte befinner Er på plats där under vinterhalvåret. Växthuset bör placeras på en skyddad del av trädgården där vinden är mindre stark. Vid montering av glaset bör handskar användas för att skydda mot skärskador. Följ de lokala lagar vad gäller bygglösa.

Monteringsföljd

Monteringsföljden är den samma för alla JUNIOR växthusen.

- Sortera upp profilerna och placera dem i den ordning som de skall monteras.
- Montera ihop hela aluminiumkonstruktionen innan glasning.
- Kryssmät diagonalerna noggrant samt använd ett vattenpass innan glasningen.
- Glasning.

Verktyg Som behövs vid montering

Fast nyckel nr. 10 eller hylsnyckel nr. 10.
Vattenpass.
Skruvmejsel.
Sax (för klippning av gummilist).
Borrmaskin och borrar 4.2 mm samt 6.5 mm.

Vi förbehåller oss för rätten att ändra i konstruktionen utan att i förväg meddela sådant.

Informazioni generali sul Prodotto

Caro Cliente,

Ti ringraziamo per aver scelto una Serra in alluminio modello JUNIOR di "alta-qualità".

Osservazioni

Nei disegni sono specificate le istruzioni di montaggio per tutti i modelli standard. In ogni caso questo manuale risulta essere una guida più che sufficiente anche per l'installazione di Serre realizzate "su misura". I profili d'alluminio potrebbero presentare alcune macchie scure. Tali macchie non sono dovute ad errori di produzione e possono altresì essere rimosse usando comuni prodotti

per la pulizia dell'alluminio, disponibili nelle migliori rivendite specializzate.

Le guarnizioni in gomma sono trattate con olii speciali al fine di facilitarne l'applicazione. Il terreno sul quale viene posata la serra deve essere opportunamente isolato e predisposto per la realizzazione di una fondamenta in cemento.

In inverno, è consigliabile rimuovere la neve dal tetto o supportare la Serra dall'interno. Consigliamo inoltre di installare la Serra in una zona riparata dal vento.

Durante la fase di installazione è preferibile usare dispositivi ed attrezzatura di protezione personale (es.: guanti) allo scopo di evitare qualsiasi danno alle persone.

Consigliamo vivamente di verificare le normative locali vigenti in merito alla realizzazione di strutture di questa tipologia.

Fasi di montaggio

La procedura di installazione è uguale per tutte le Serre modello JUNIOR.

- Verificare e disporre in ordine tutti i profili in alluminio che compongono la Serra.
- Montare completamente la struttura in alluminio.
- Livellare la struttura e controllarne lo squadra degli angoli e delle diagonali.
- Posizionare le lastre di tamponamento (vetro, policarbonato etc.).

Attrezzatura necessaria per il montaggio

Chiave inglese o chiave a bussola nr.10, livella ad acqua (bolla), cacciavite, trapano con punta ø4 mm, forbici (per tagliare la guarnizione).

Ci riserviamo il diritto di apportare eventuali modifiche del prodotto in qualsiasi momento e senza preavviso.

" JUNIOR "

A	X	B
2.360mm		3.098mm
		3.836mm
		4.574mm

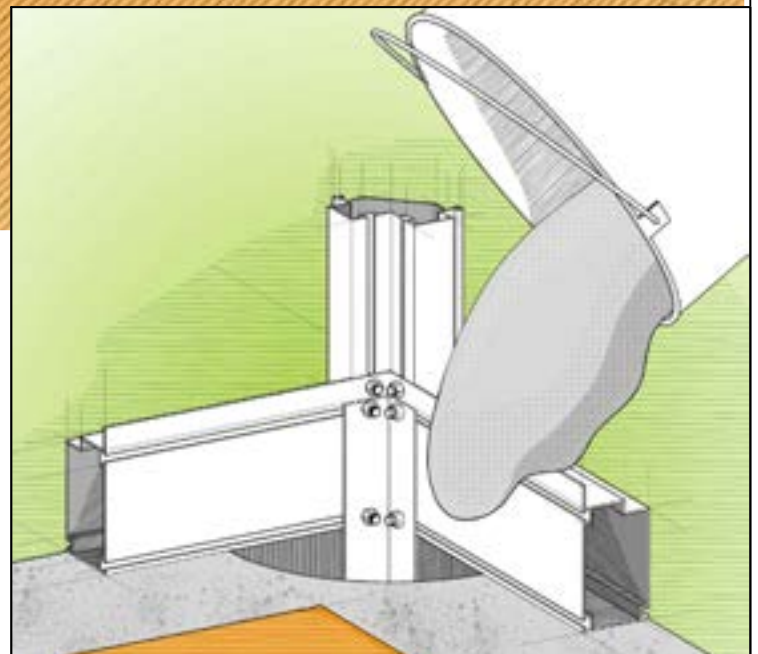
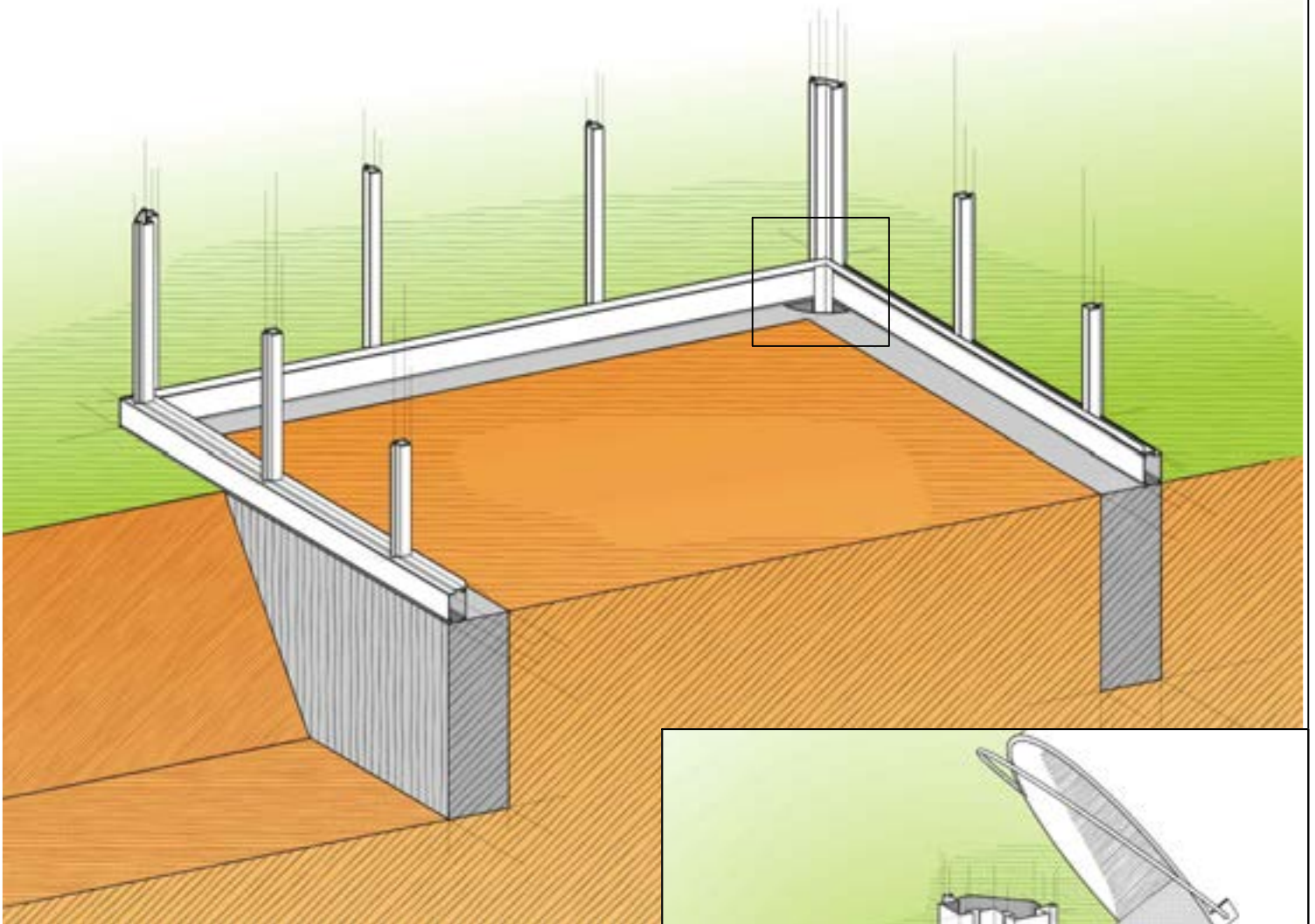
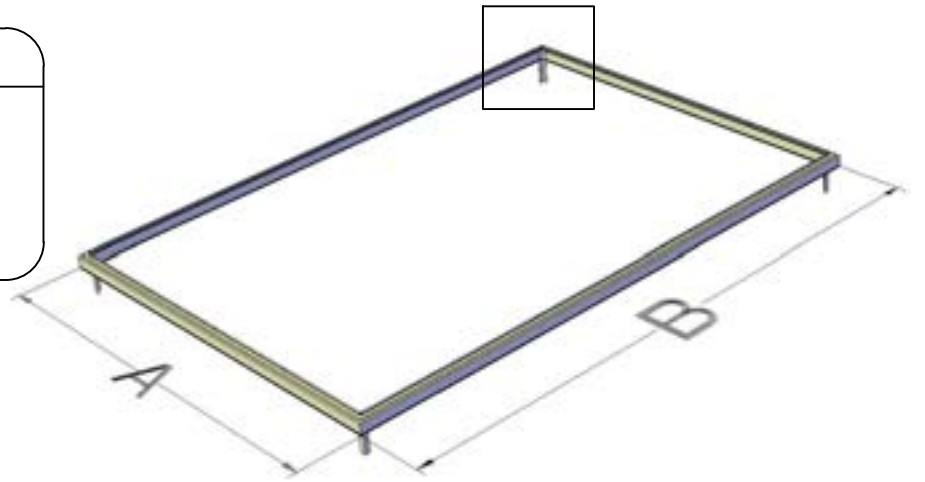

STANDING PALETT

WEIGHT:	
123	386 kg
124	435 kg
125	485 kg
DIMENSIONS:	
800 x 900 x 2200 mm	

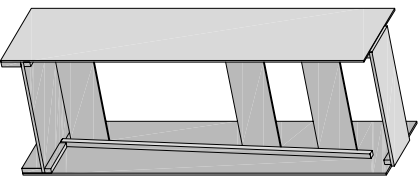

ITEM	J23	J24	J25
DAKR_HEL	1 pc	2 pc	2 pc
ZAKIE_H	1 pc	1 pc	1 pc
PRO6578 corner profile	1430 mm 4 pc	4 pc	4 pc
PRO6918 endbar roof	1430 mm 4 pc	4 pc	4 pc
PRO1456 glazing bar	1430 mm 14 pc	18 pc	22 pc
PRO10980 round tube Ø40	1500 mm 2 pc	2 pc	2 pc
PRO1748 rubber 12,5m/rol	4 pc	4 pc	4 pc
TRE wind bradings sides	1614 mm 8 pc	8 pc	8 pc
ZAKIE_SILICONEN	1 pc	1 pc	1 pc
ESD_183_75	1 pc	1 pc	1 pc
ridge decoration (box)	1 pc	1+1 pc	1+1 pc

POSITION	GLAS DIMENSIONS	J23	J24	J25
door	730 x 1850 mm	1 pc	1 pc	1 pc
gables + roof	730 x 1450 mm	20 pc	23 pc	27 pc
triangle E3	361 x 520 x 290 mm (*70)	2 pc	2 pc	2 pc
triangle E1	730 x 680 x 85 mm	4 pc	4 pc	4 pc
triangle E2	361 x 910 x 690 (*70)	2 pc	2 pc	2 pc
roofwindow	730 x 825 mm	1 pc	2 pc	2 pc
underneed roofwindow	730 x 625 mm	1 pc	2 pc	2 pc

COLLI A JUNIOR

WEIGHT: 22 kg
DIMENSIONS: 240 x 120 x 2600 mm

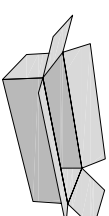

PACKING LIST "EOS JUNIOR"

ITEM	J23/J24/J25
PRO6120 foundation profile	2360mm 2 pc
PRO20229 horizontal gable prof.	2244 mm 1 pc
PRO20229 horizontal gable prof.	768mm L 1 pc
PRO20229 horizontal gable prof.	768mm R 1 pc
PRO20229 horizontal gable prof.	768mm L,R 1 pc
L 40x40 GATFUND	400 mm 4 pc
PRO1456 glazing bar	918 mm 1 pc
PRO1456 glazing bar	672 mm L 1 pc
PRO1456 glazing bar	672 mm R 1 pc
PRO1456 glazing bar	520 mm 1 pc
PRO1456 glazing bar	2130 mm L 1 pc
PRO1456 glazing bar	2130 mm R 1 pc
TRE wind bradings sides	2065 mm 2 pc
SAPAK_EOS	1 pc

COLLI B EOS & JUNIOR

WEIGHT:	DIMENSIONS:
123 30 kg	240 x 120 x 3200 mm J23
124 35 kg	4000 mm J24
125 40 kg	4700 mm J25

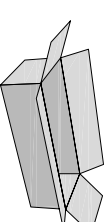

ITEM	J23	J24	J25
PRO6120 foundation profile	3098 mm 2 pc	3836 mm 2 pc	4574 mm 2 pc
PRO20779 gutter profile	3098 mm 2 pc	3836 mm 2 pc	4574 mm 2 pc
PRO40091 ridge profile	3098 mm 1 pc	3836 mm 1 pc	4574 mm 1 pc
ZAKIE_BOUT_?	3 pc	3 pc	3 pc

GLASS-SET EOS JUNIOR 23 236x310

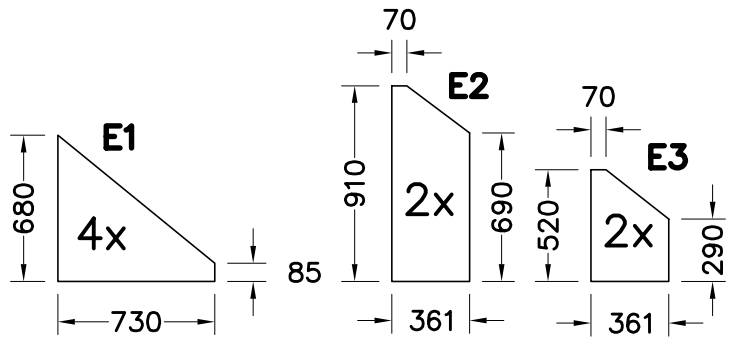
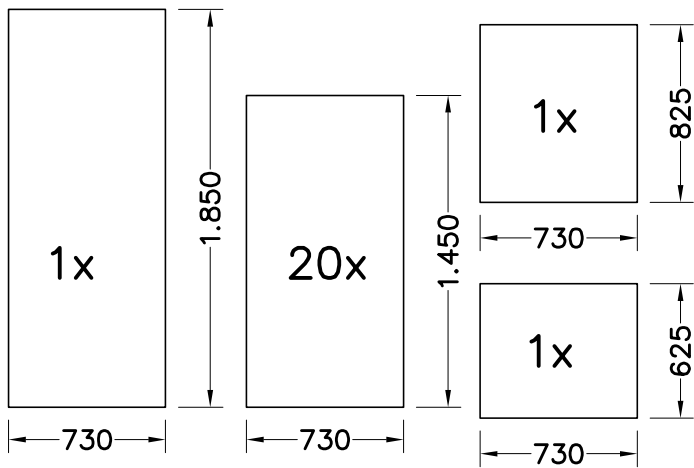

GLASS-SET EOS JUNIOR 24 236x384

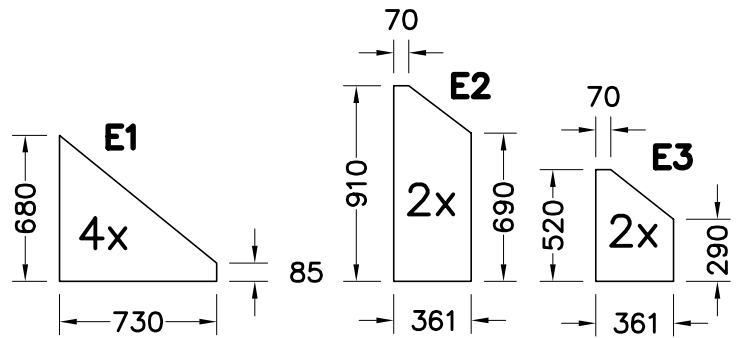
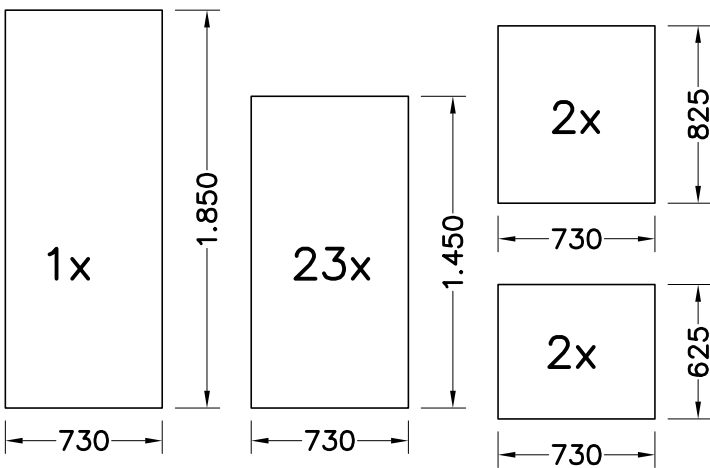

GLASS-SET EOS JUNIOR 25 236x458

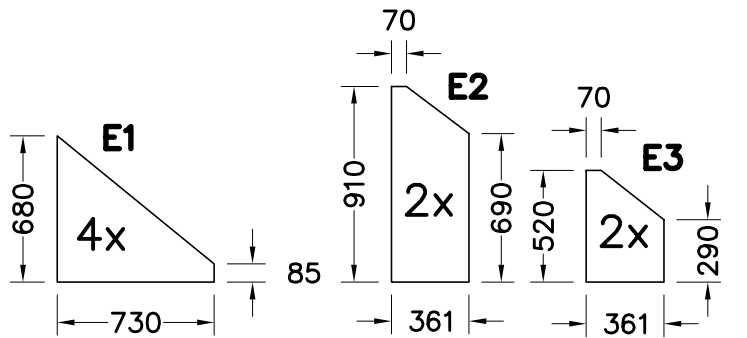
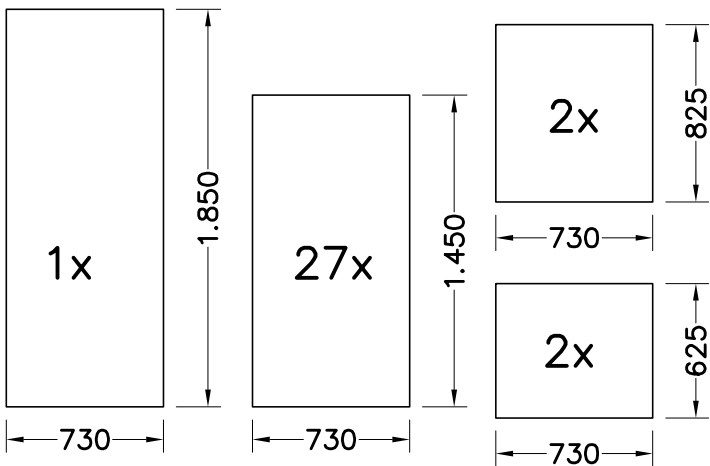

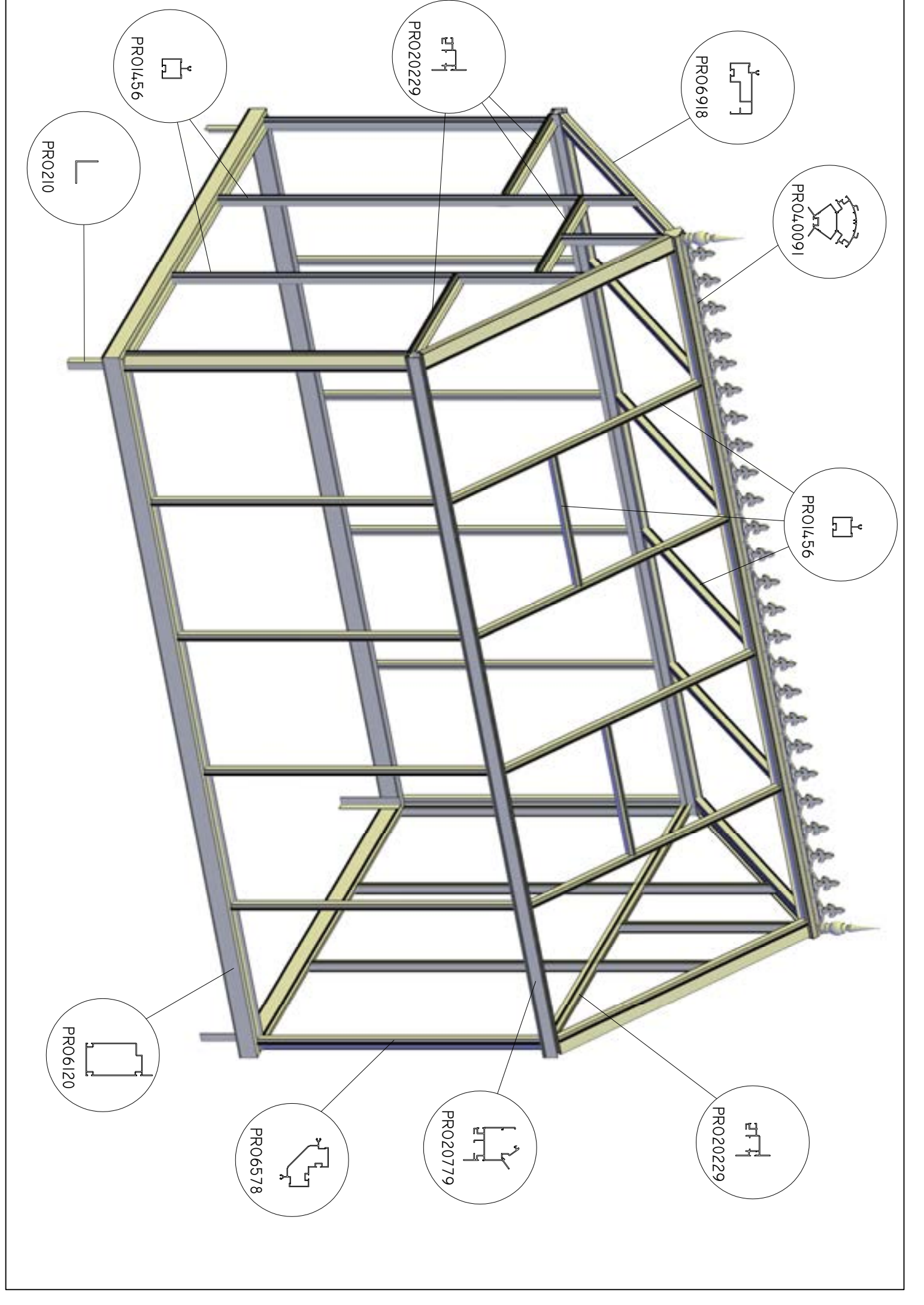

PR06918

PR040091

PR01456

PR020229

PR020229

PR020779

PR06578

PR01456

PR06120

PR0210



ITEM	Pc.	JH23	JH24	JH25
	4 pc.	400 MM	400 MM	400 MM
PR06120	2 pc.	2.360 MM	2.360 MM	2.360 MM
PR06120	2 pc.	3.098 MM	3.836 MM	4.574 MM
	16 pc.			
M6x50	16 pc.			

A

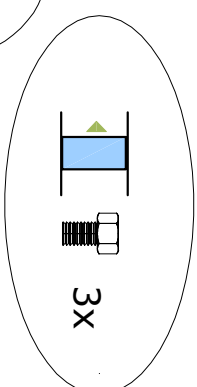
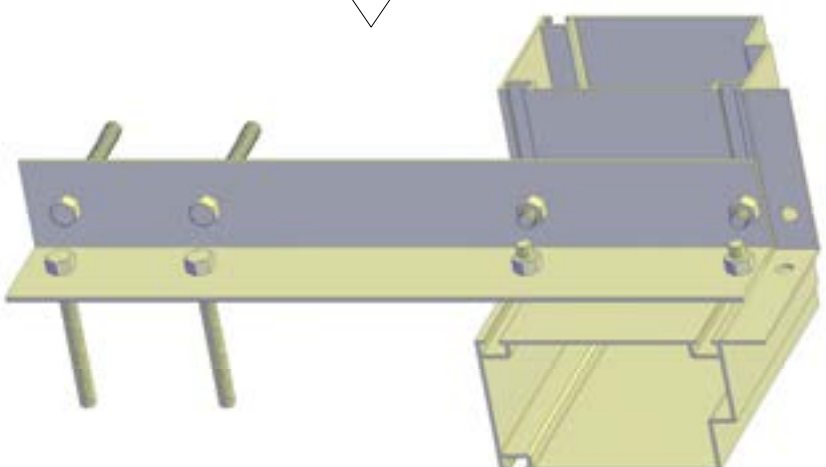
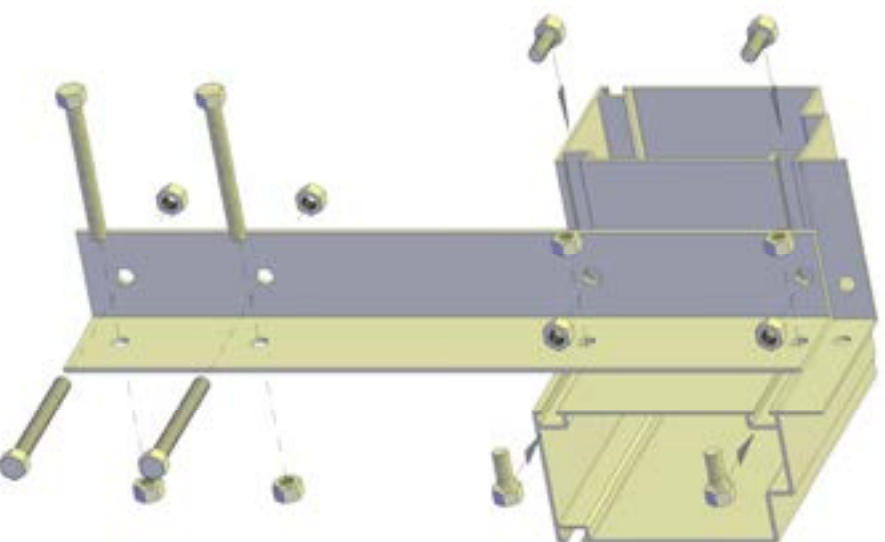
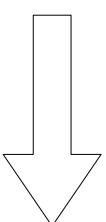

EOS JUNIOR 1

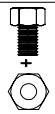
ITEM	PC.	JH23/24/25
PR06578	4 PC.	1.430MM
 M6X15	8 PC.	

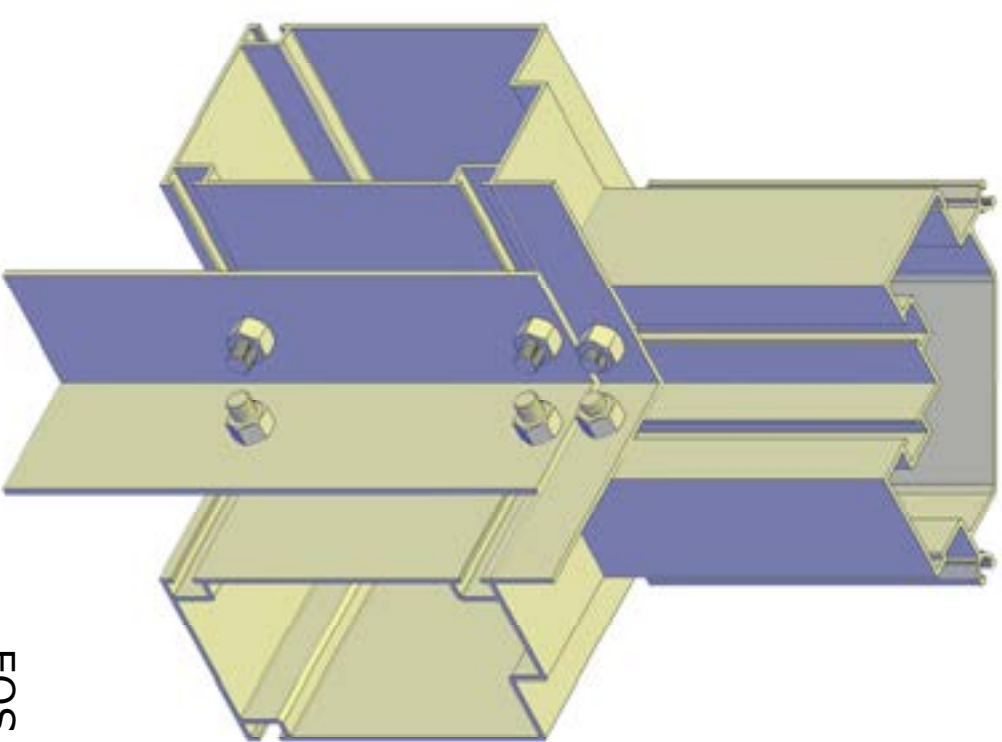
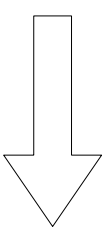
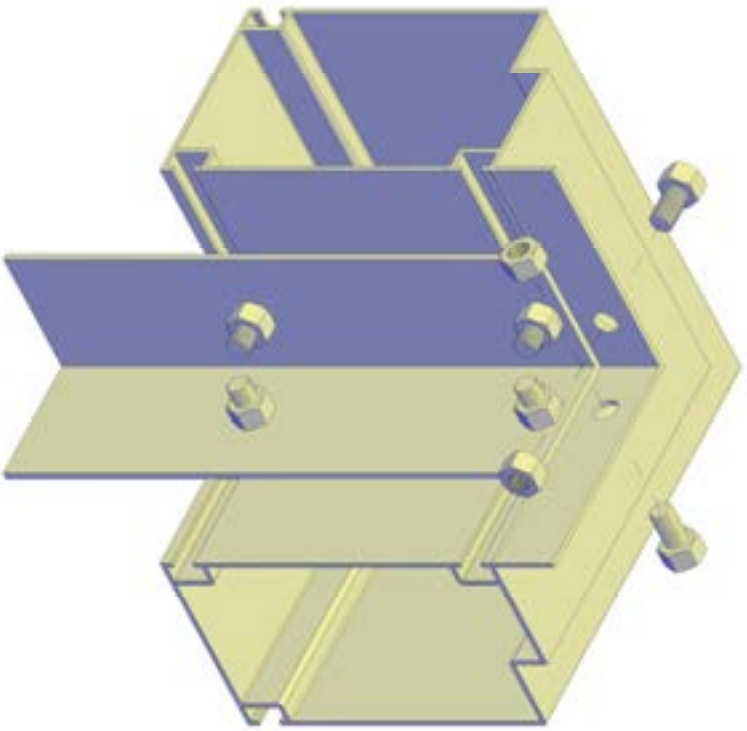
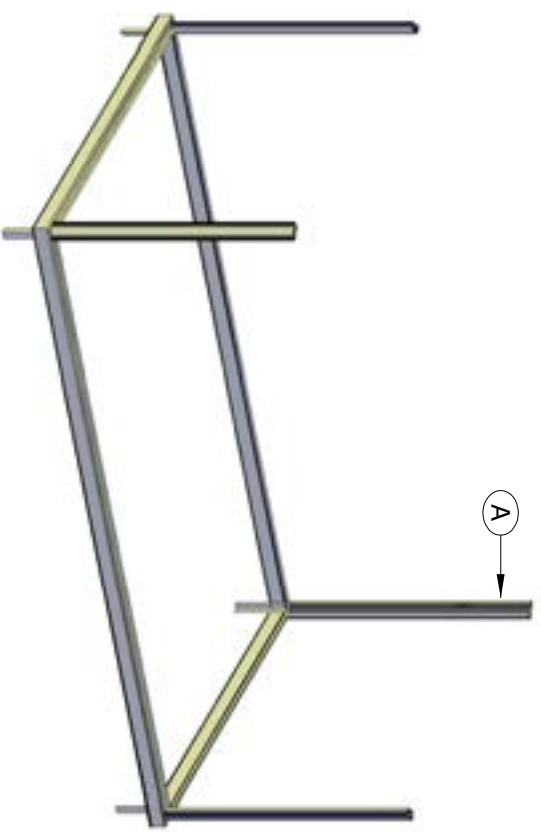

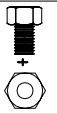

EOS JUNIOR 2

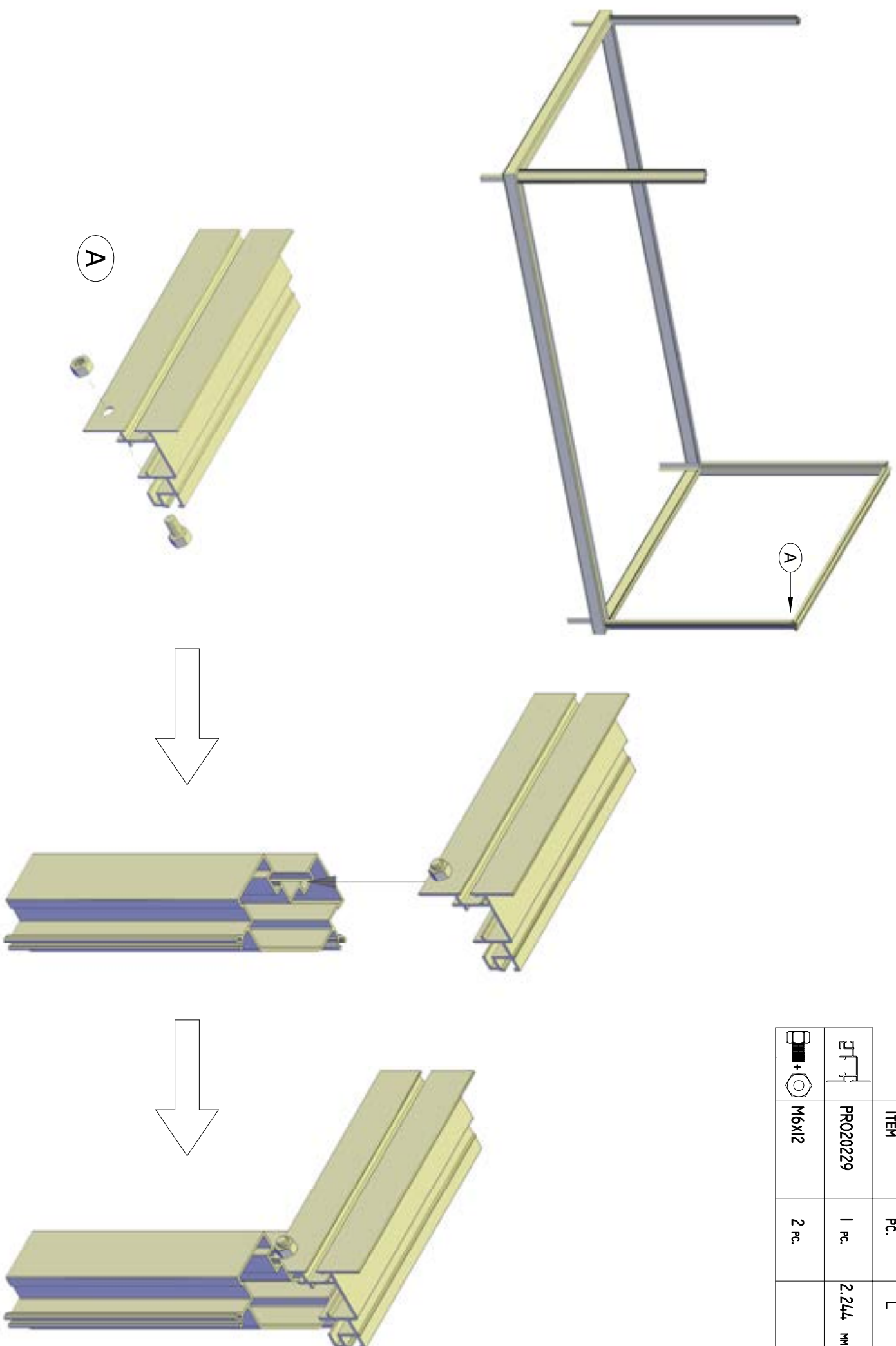
ITEM	PC.	L
 PRO20229	1 PC.	2.244 MM
 M6X12	2 PC.	



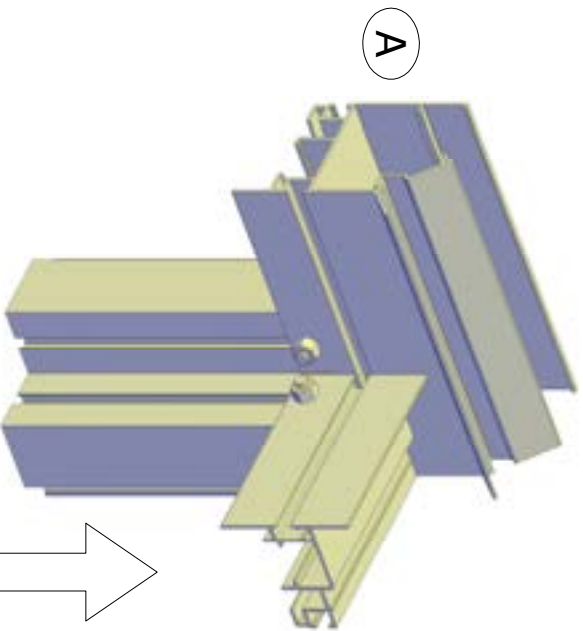
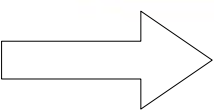
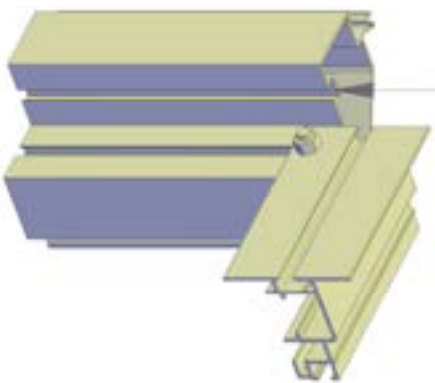
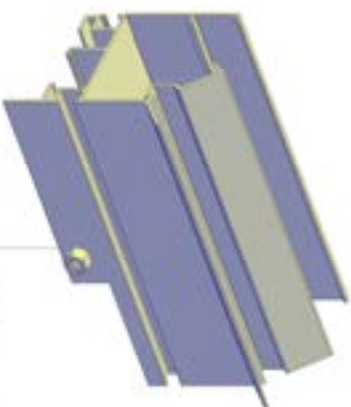
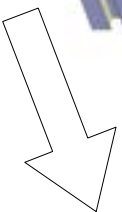
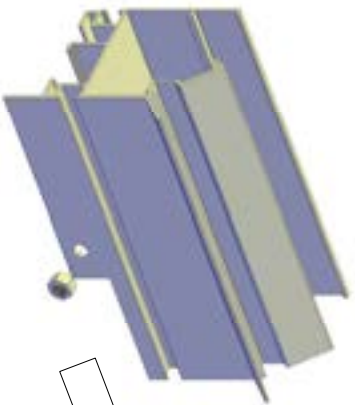
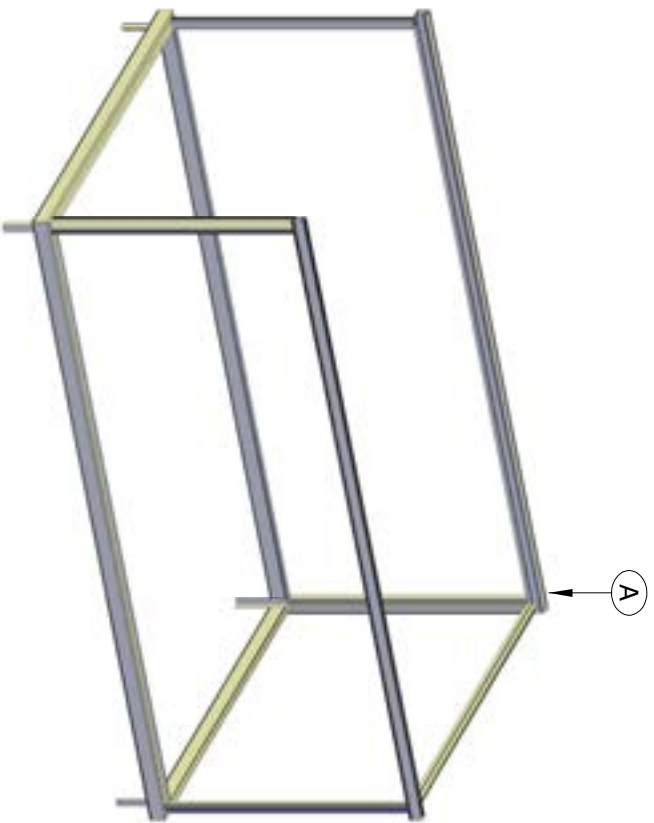

EOS JUNIOR 3

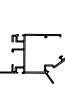

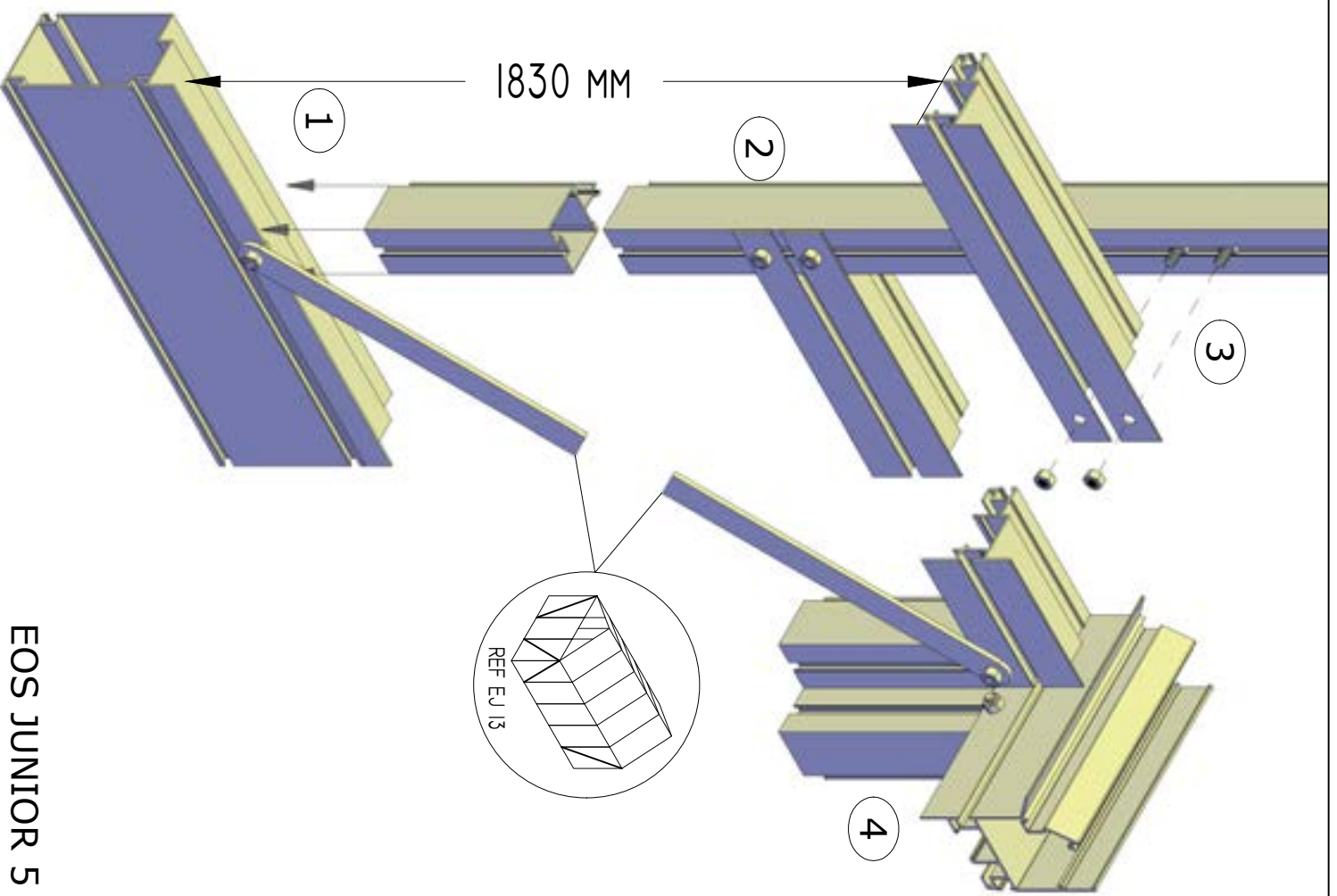
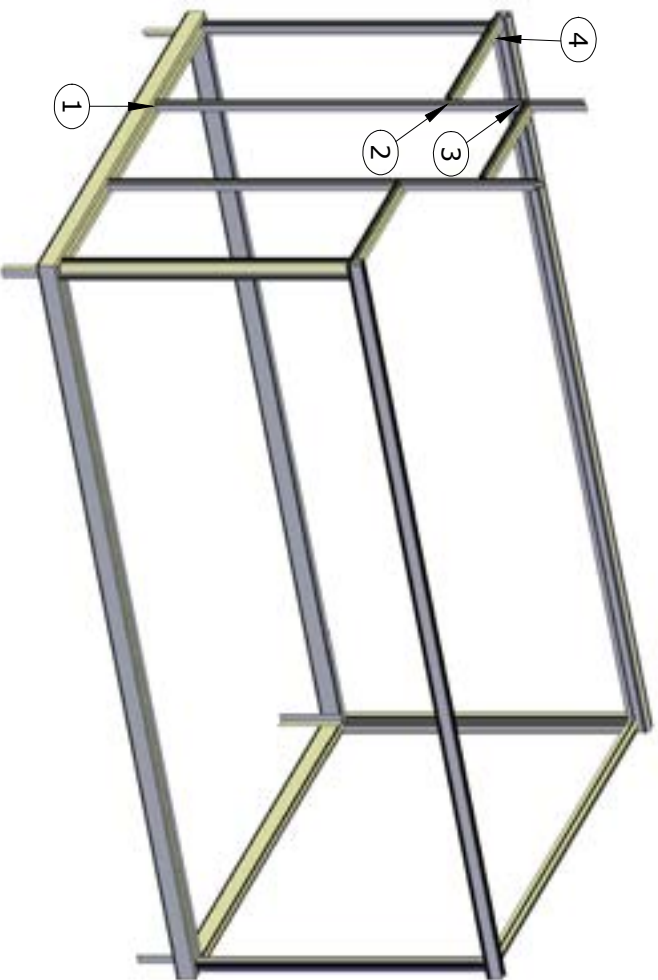
		ITEM	P.C.	JH23	JH24	JH25
M6X15	PRO20779	2 P.C.	3.098 MM	3.836 MM	4.574 MM	
		4 P.C.				



ITEM	P.C.	L
 PR0202229	3 P.C.	768 MM L + R + LR
 PR01456	2 P.C.	2.130 MM
 M6X12	12 P.C.	

EOS JUNIOR 5

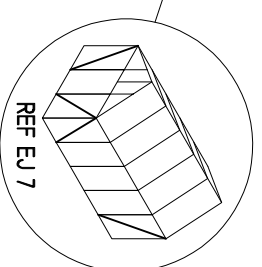
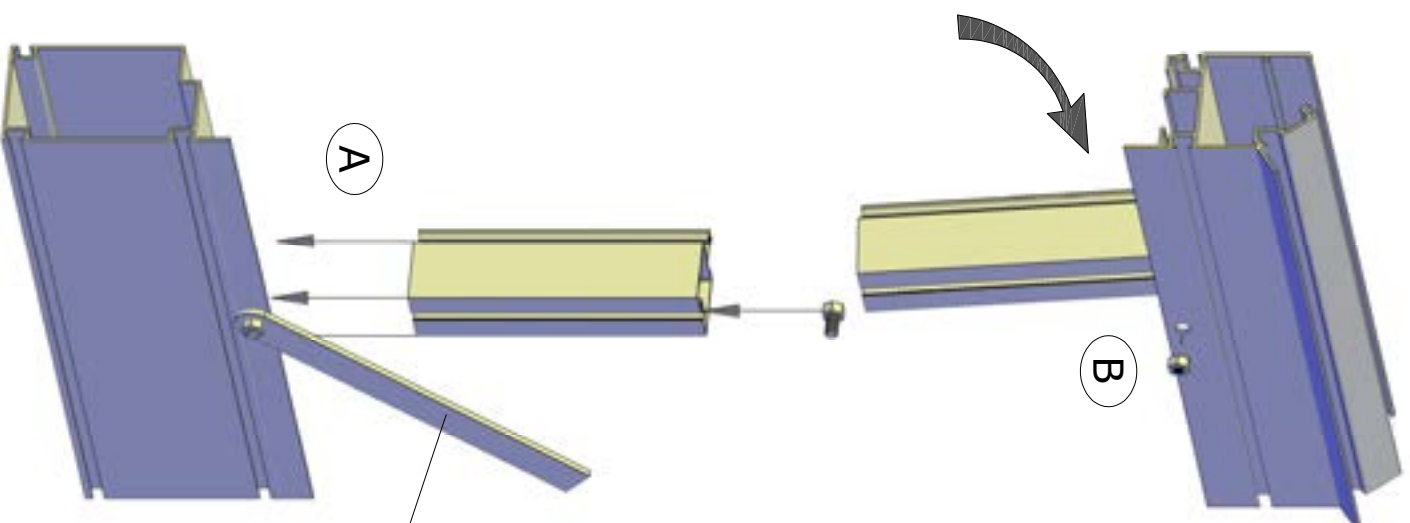
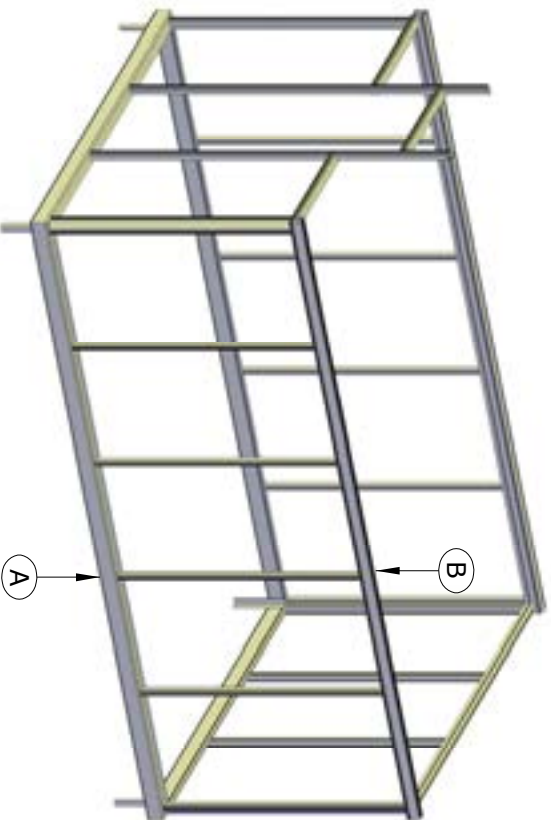

ITEM	L	JH23	JH24	JH25
PRO1456	1.430 MM	8 PC.	10 PC.	12 PC.
M6X15		16 PC.	20 PC.	24 PC.

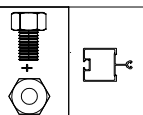

EOS JUNIOR 6

	ITEM	Pc.	L
TRE	8 Pc.	1.611 MM	

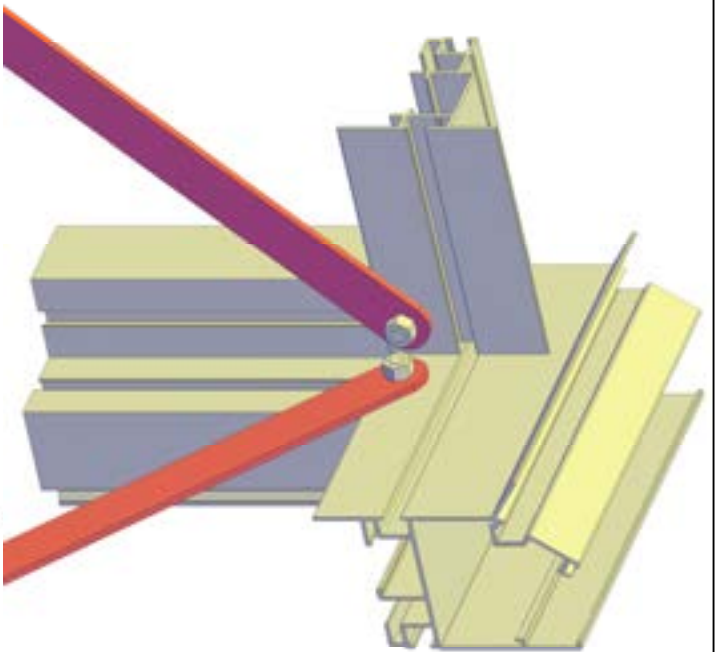
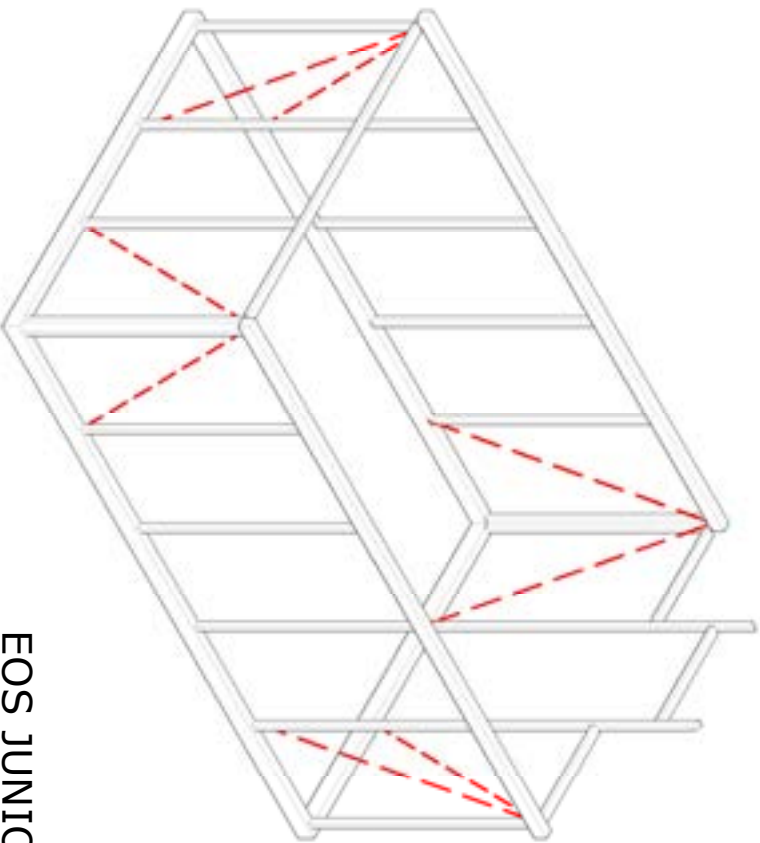
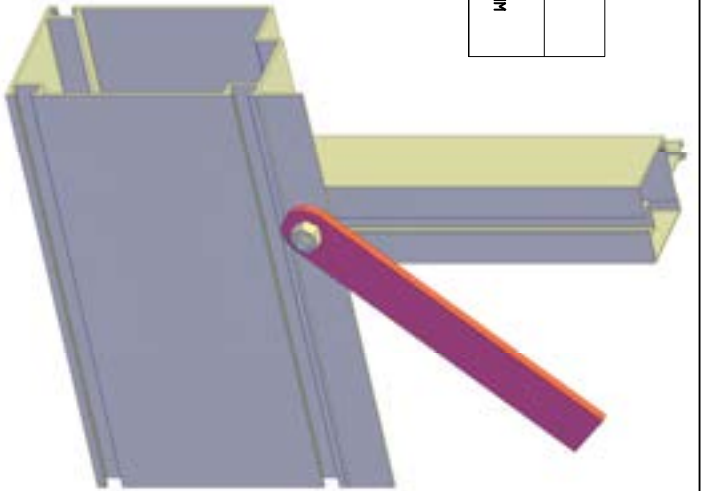
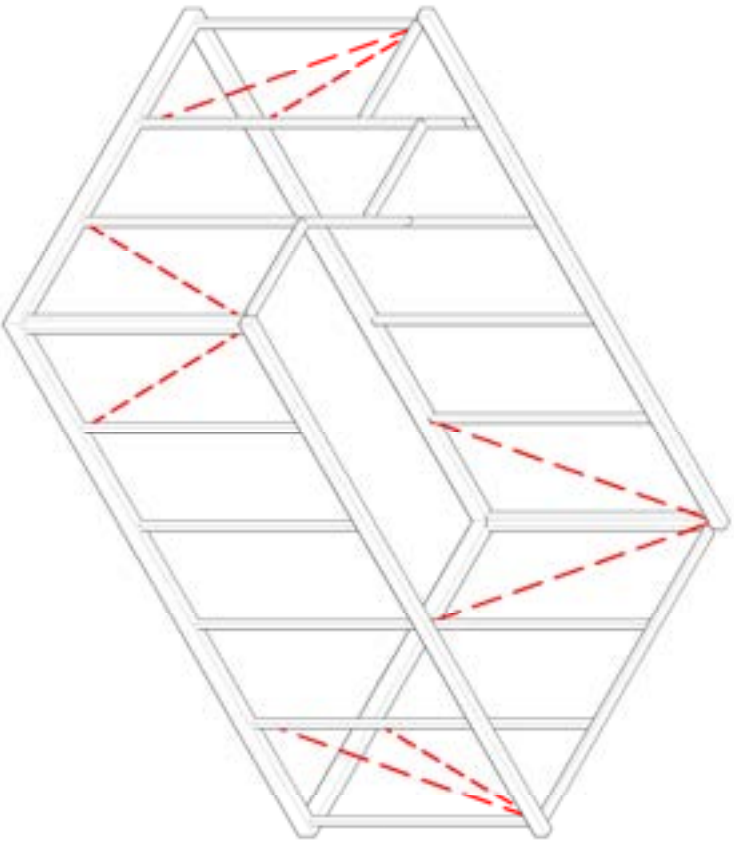

EOS JUNIOR 7

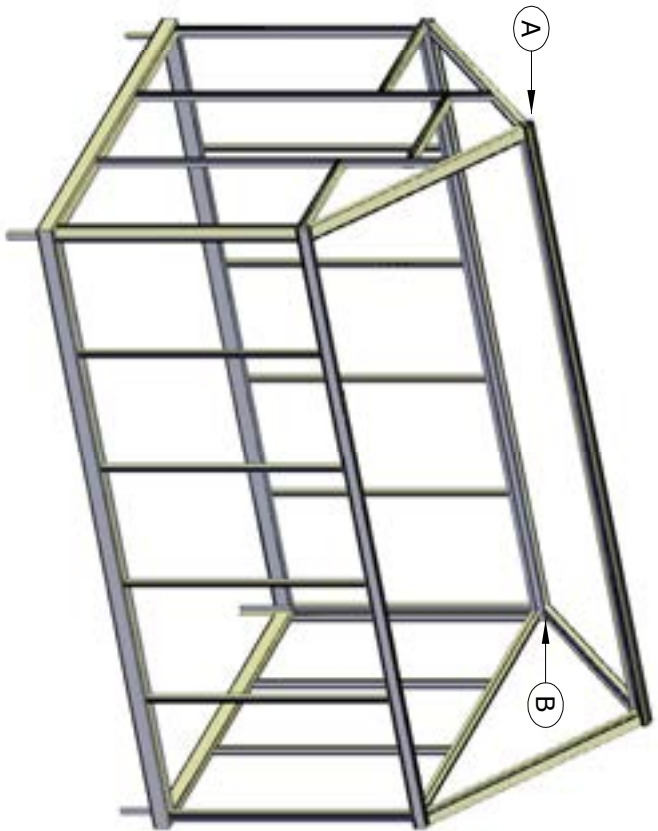

PAG. EJ 11

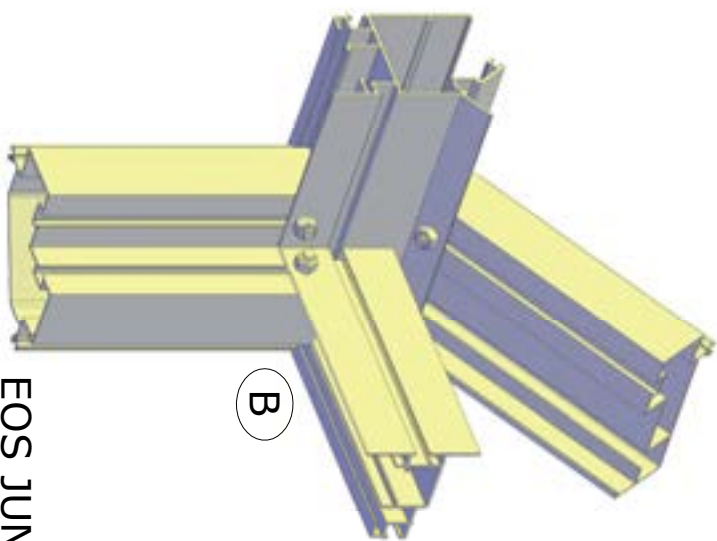
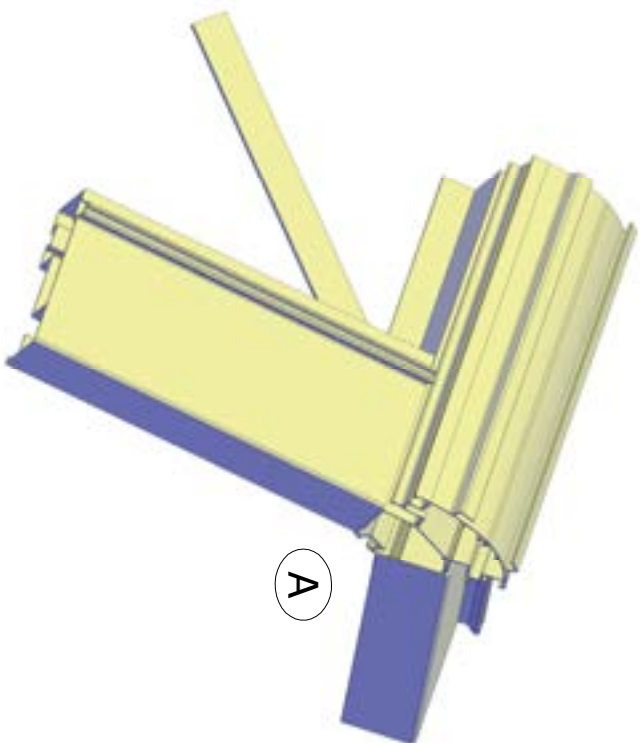
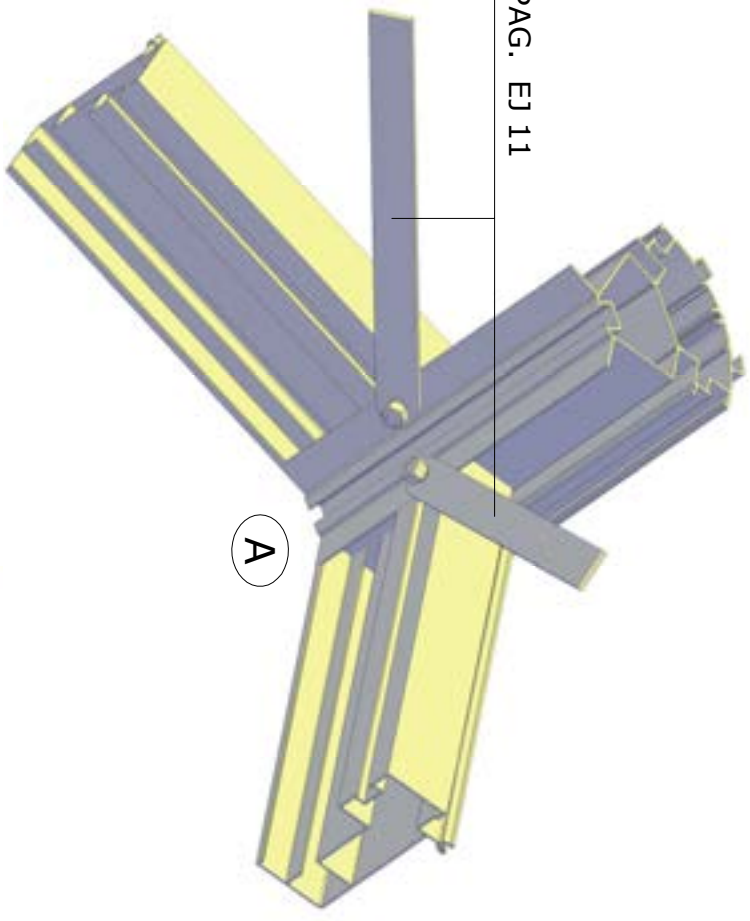



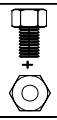
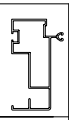

EOS JUNIOR 8

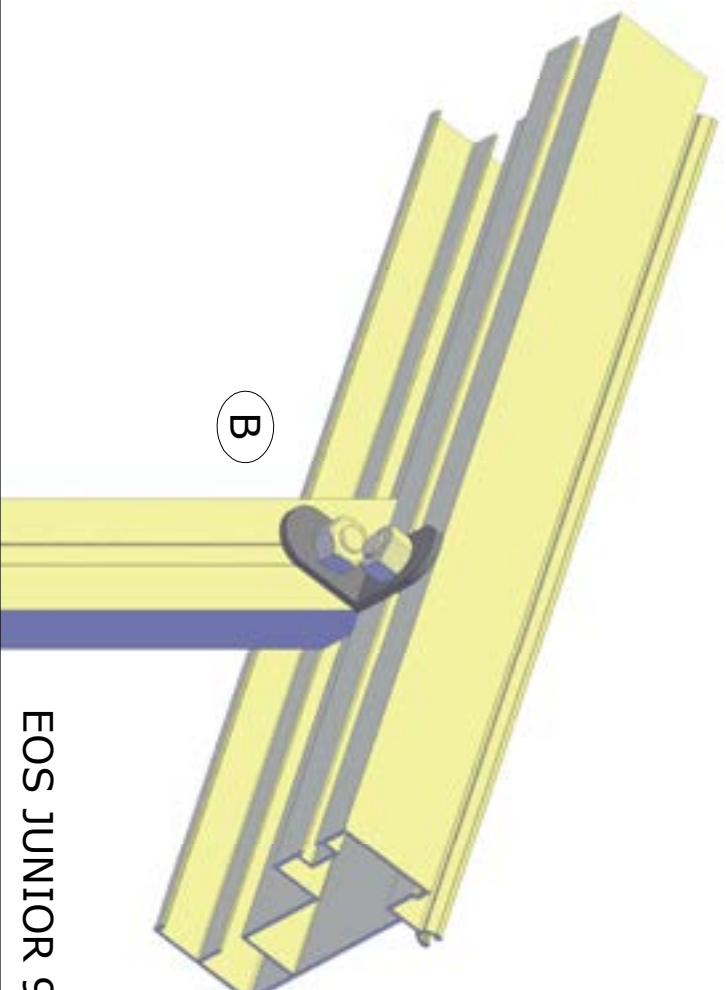
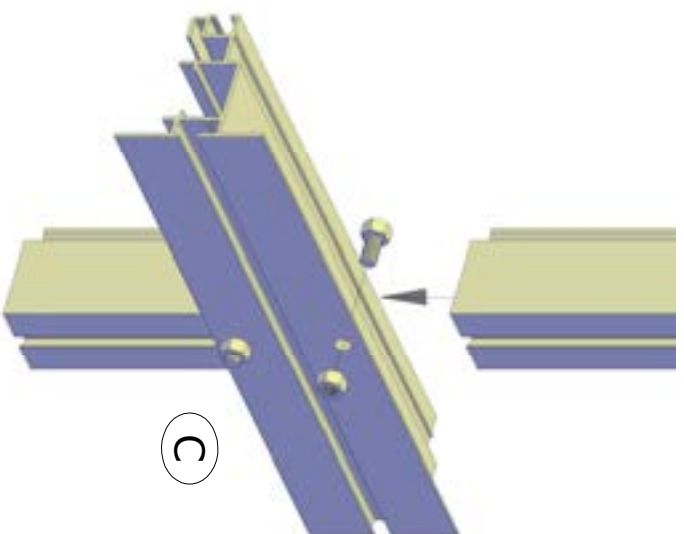
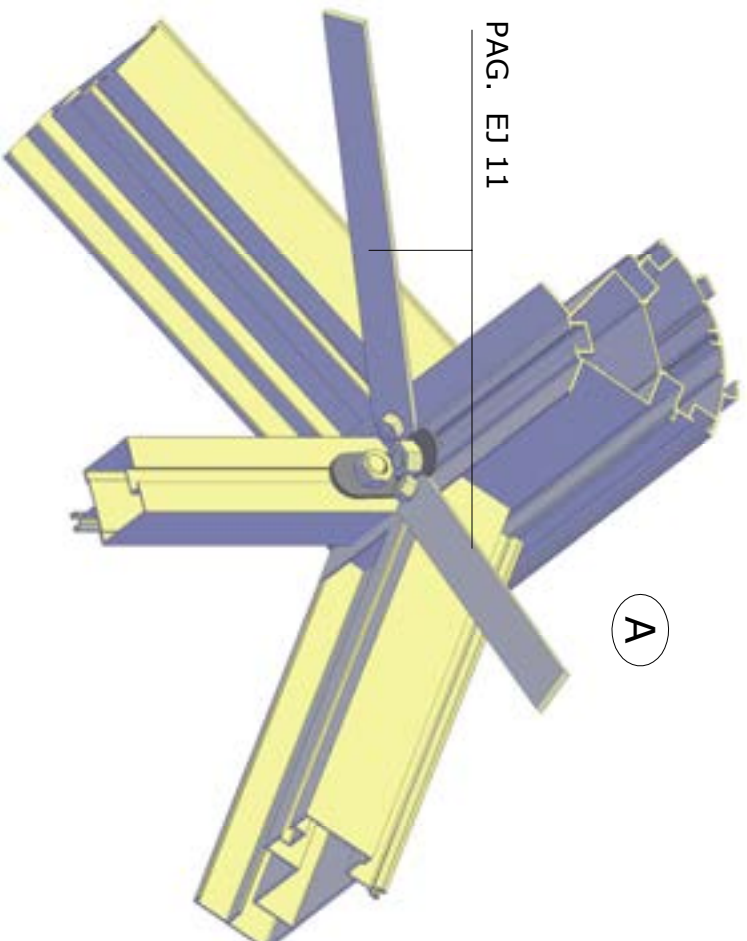
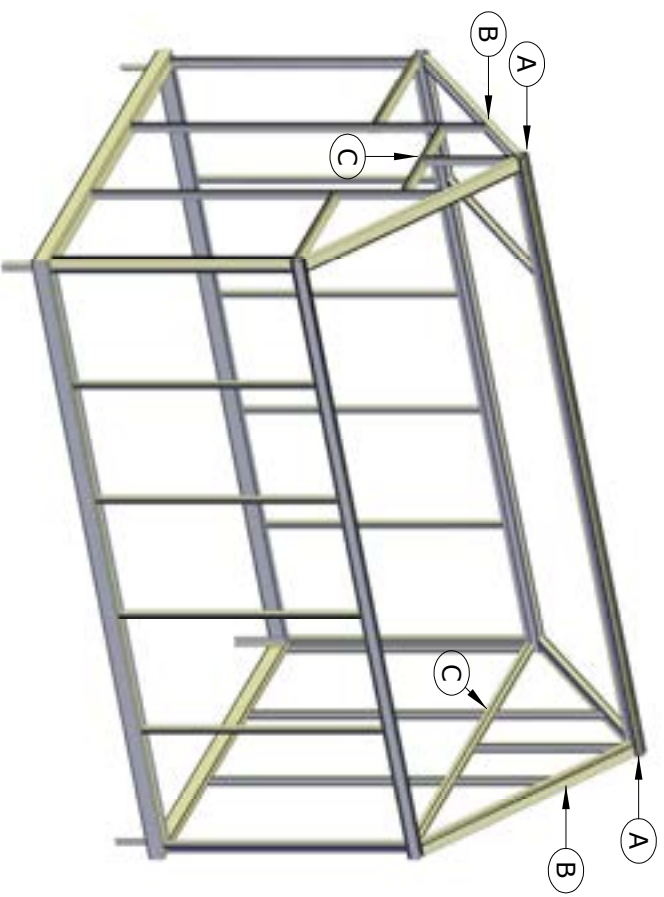
ITEM	PC.	JH23	JH24	JH25
PR06918	4 PC.	1.430MM	1.430MM	1.430MM
PR040091	1 PC.	3.098MM	3.836MM	4.574MM
M6X15	8 PC.	8 PC.	8 PC.	8 PC.





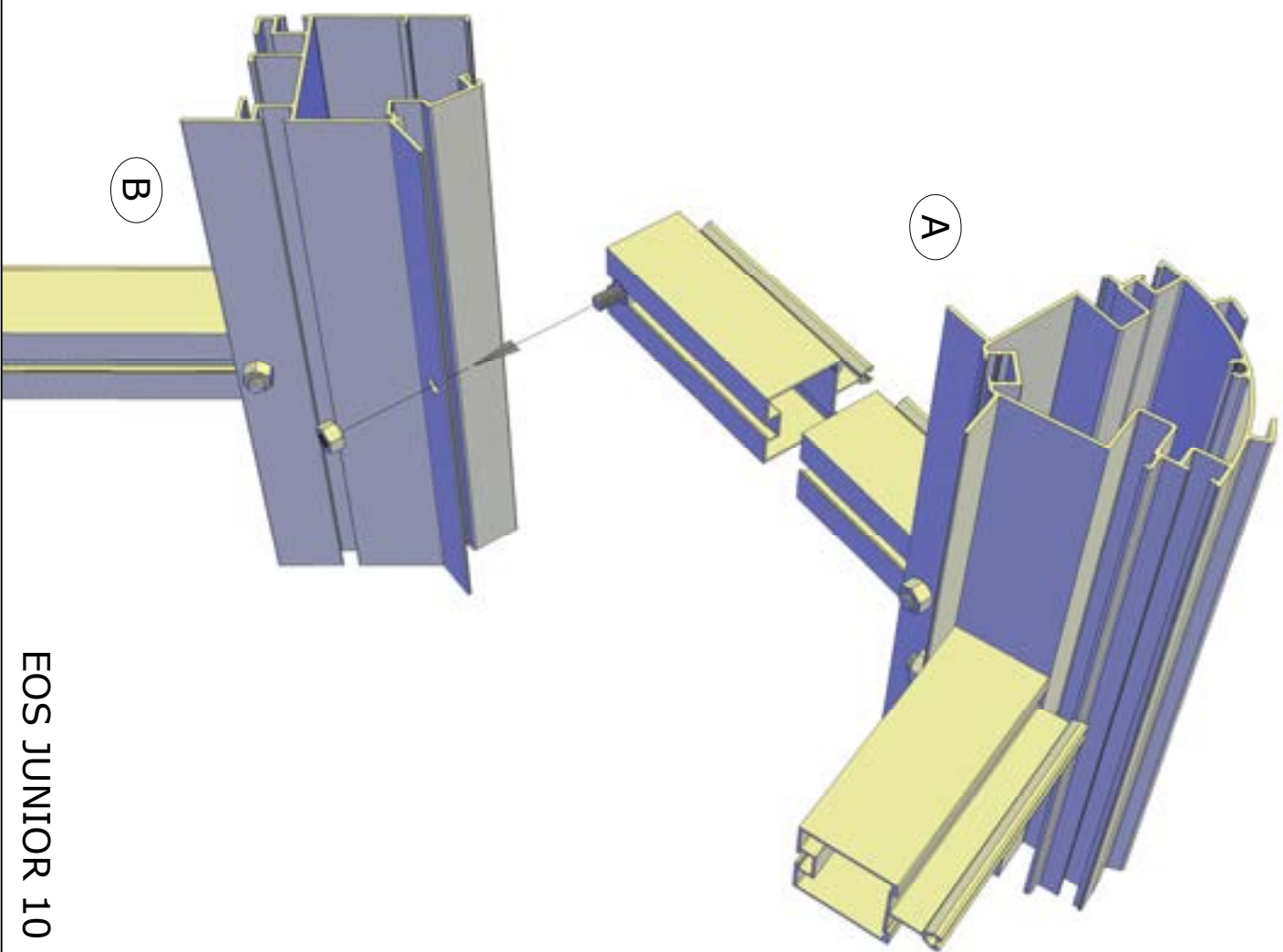
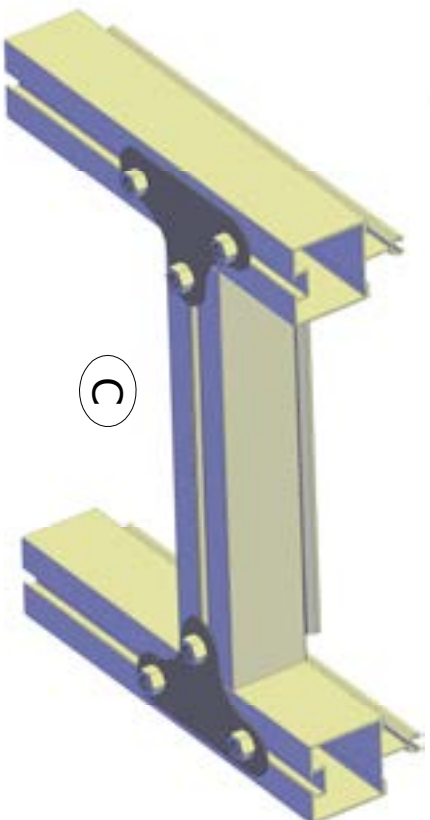
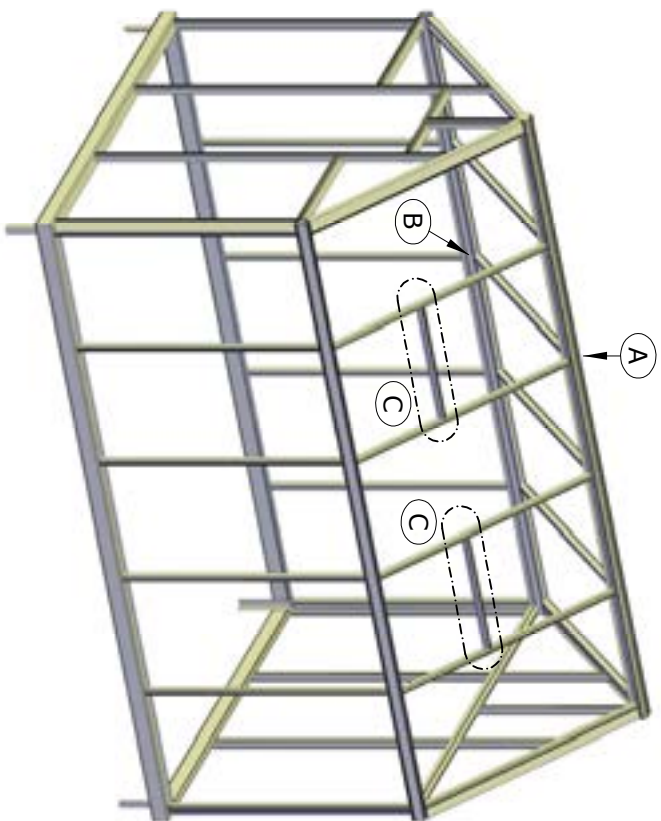

ITEM	P.C.	L
 PR01456	1 pc.	918 MM
 PR01456	2 pc.	672 MM
 PR01456	1 pc.	520 MM
 M6X12	16 pc.	
 LG	6 pc.	

EOS JUNIOR 9



ITEM	L	JH23	JH24	JH25
PRO1456	1.430 MM	6 PC.	8 PC.	10 PC.
PRO1456	703 MM	1 PC.	2 PC.	2 PC.
M6X15		18 PC.	28 PC.	32 PC.
		2 PC.	4 PC.	4 PC.

EOS JUNIOR 10

	ITEM	PC.	JH23/24/25
	TRE	4 PC.	2.060 MM
		4 PC.	

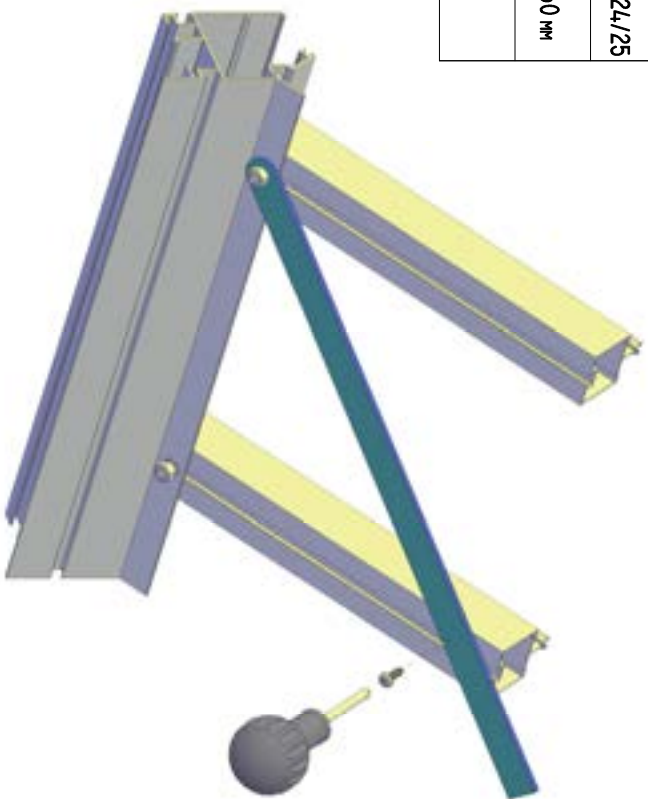

X = EXTRA FIXING / EXTRA BEFESTIGUNG / ATTACH EXTRA

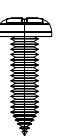
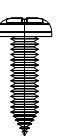
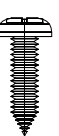
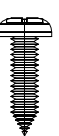
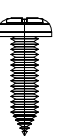
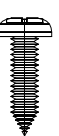
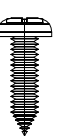
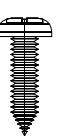
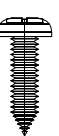
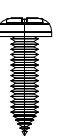
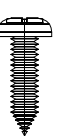
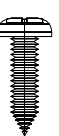
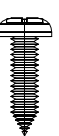
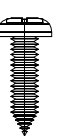
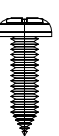
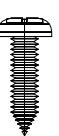
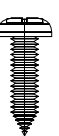
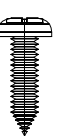
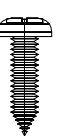
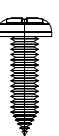
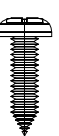
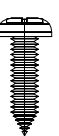
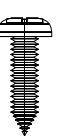
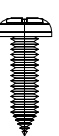
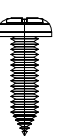
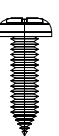
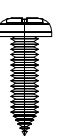
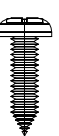
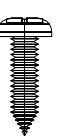
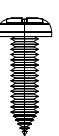
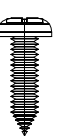
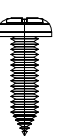
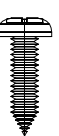
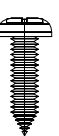
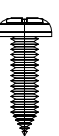
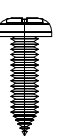
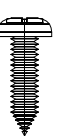
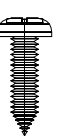
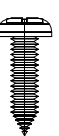
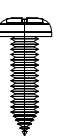
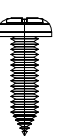
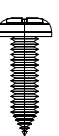
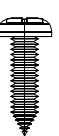
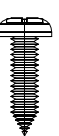
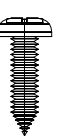
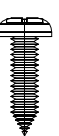
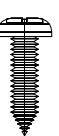
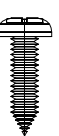
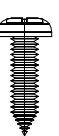
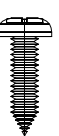
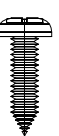
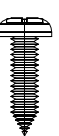
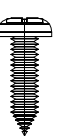
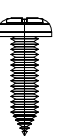
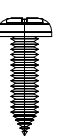
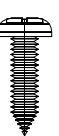
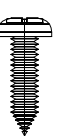
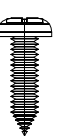
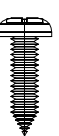
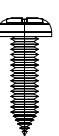
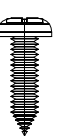
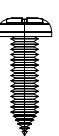
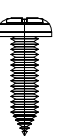
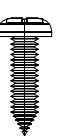
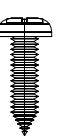
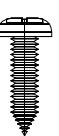
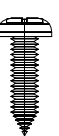
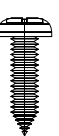
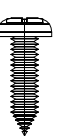
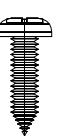
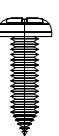
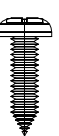
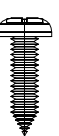
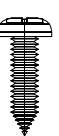
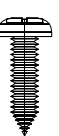
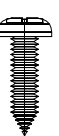
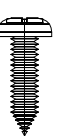
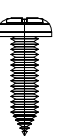
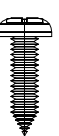
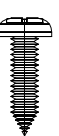
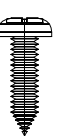
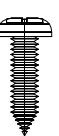
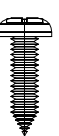
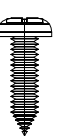
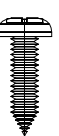
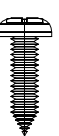
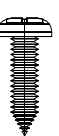
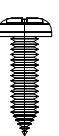
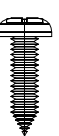
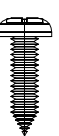
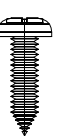
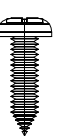
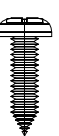
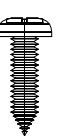
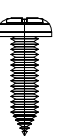
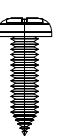
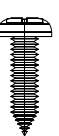
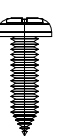
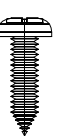
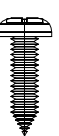
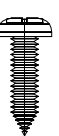
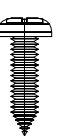
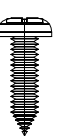
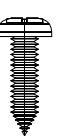
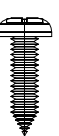
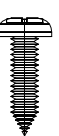
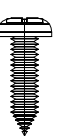
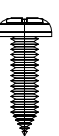
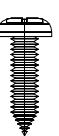
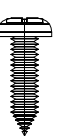
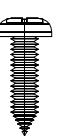
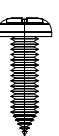
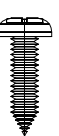
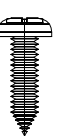
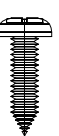
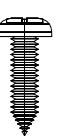
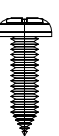
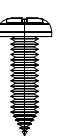
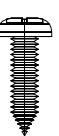
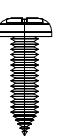
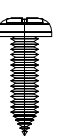
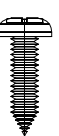
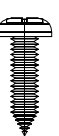
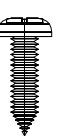
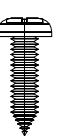
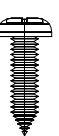
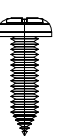
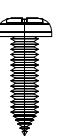
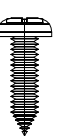
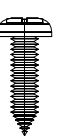
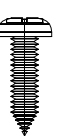
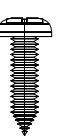
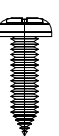
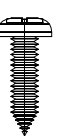
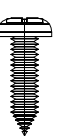
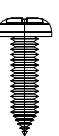
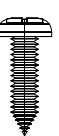
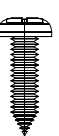
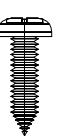
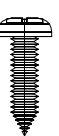
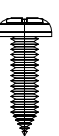
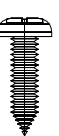
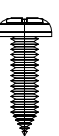
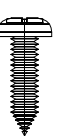
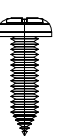
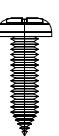
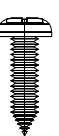
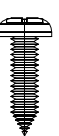
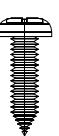
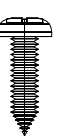
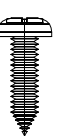
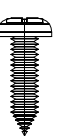
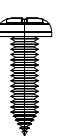
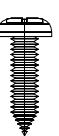
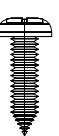
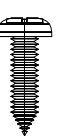
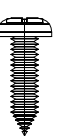
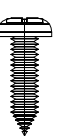
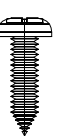
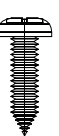
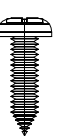
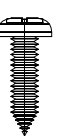
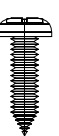
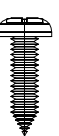
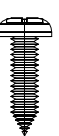
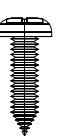
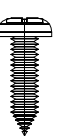
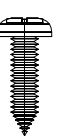
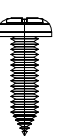
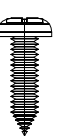
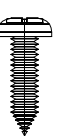
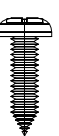
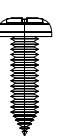
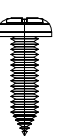
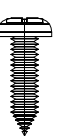
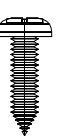
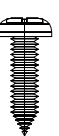
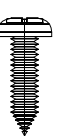
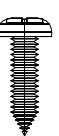
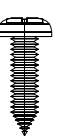
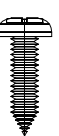
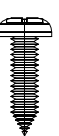
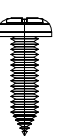
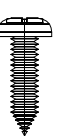
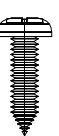
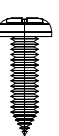
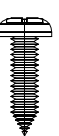
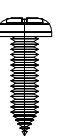
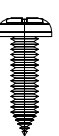
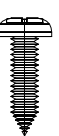
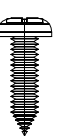
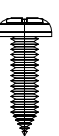
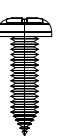
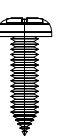
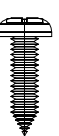
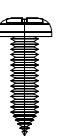
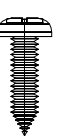
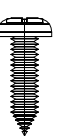
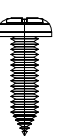
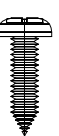
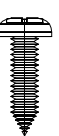
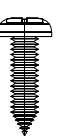
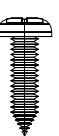
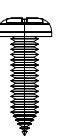
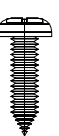
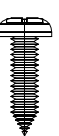
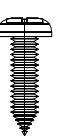
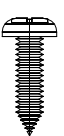

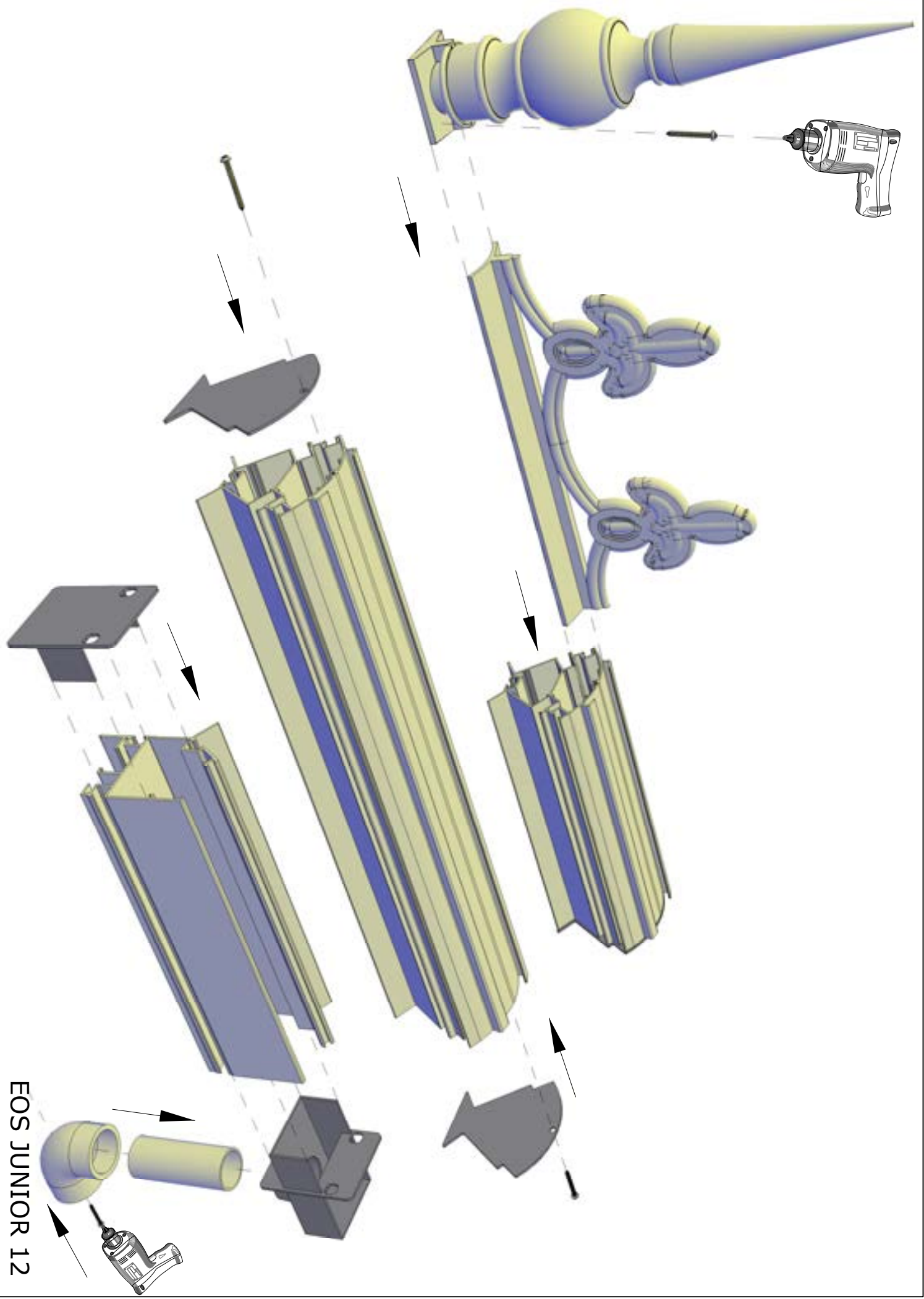

EOS JUNIOR 12

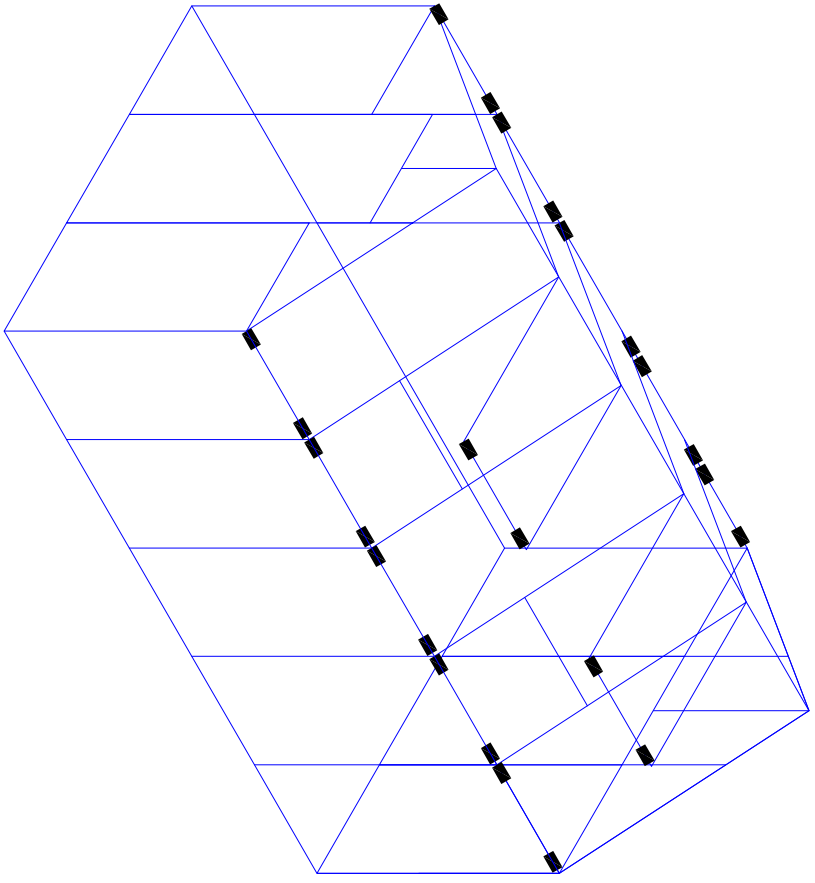

Pro 20780

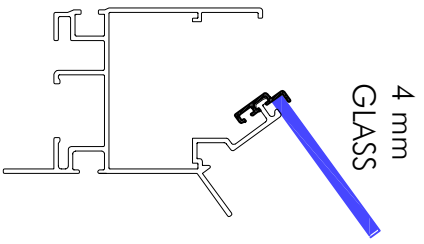

4 mm
GLASS

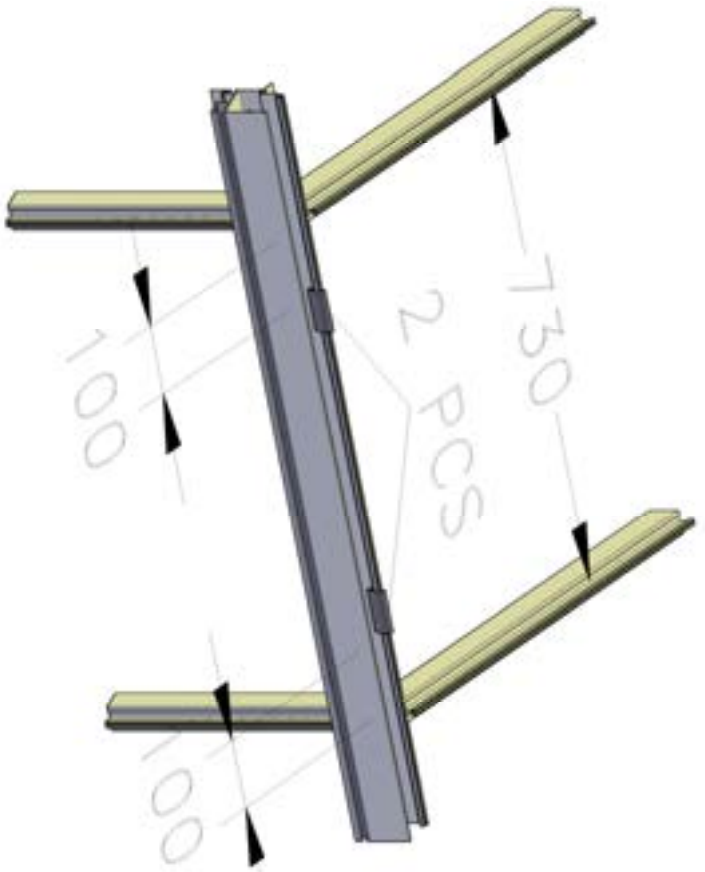

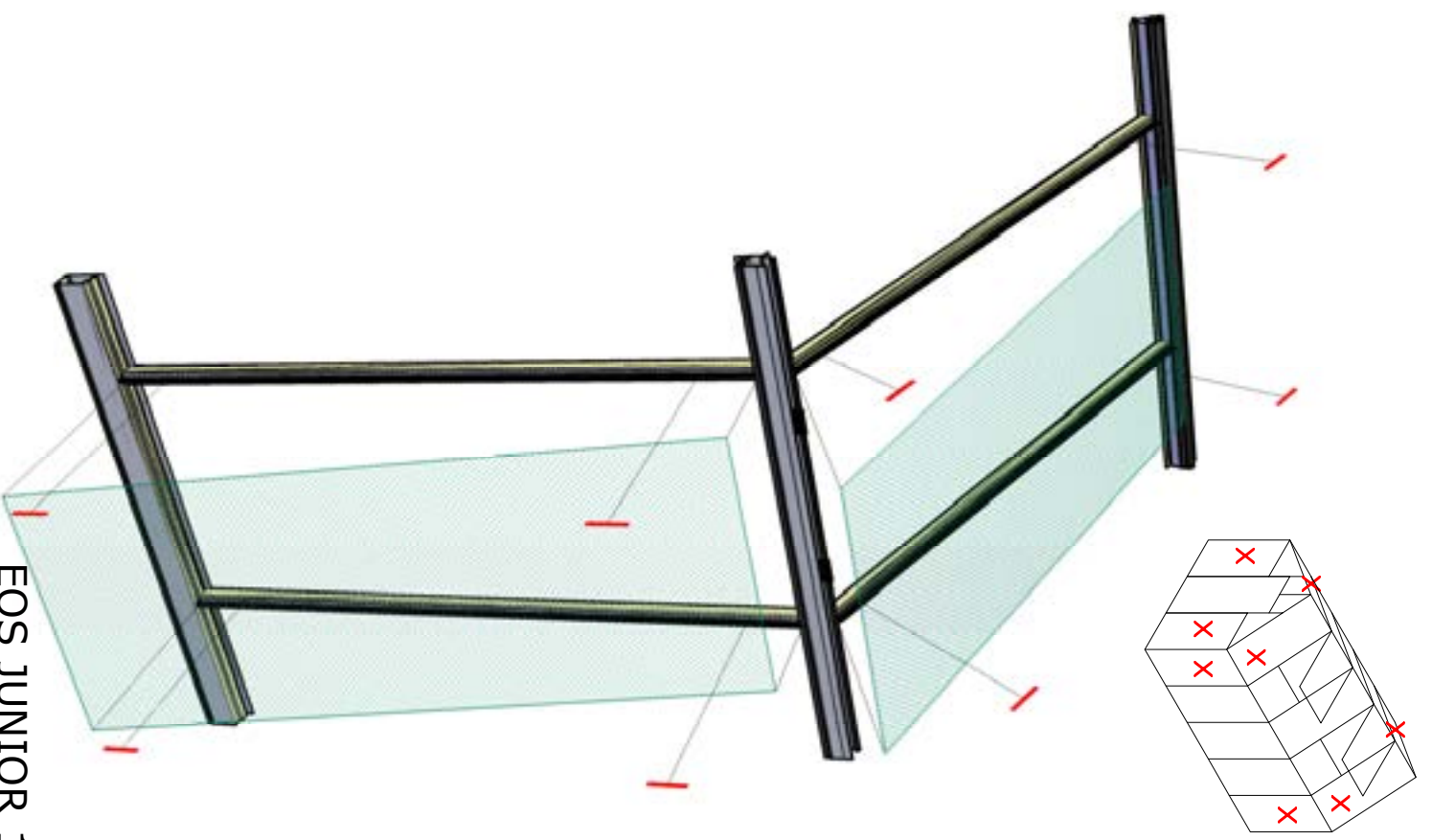
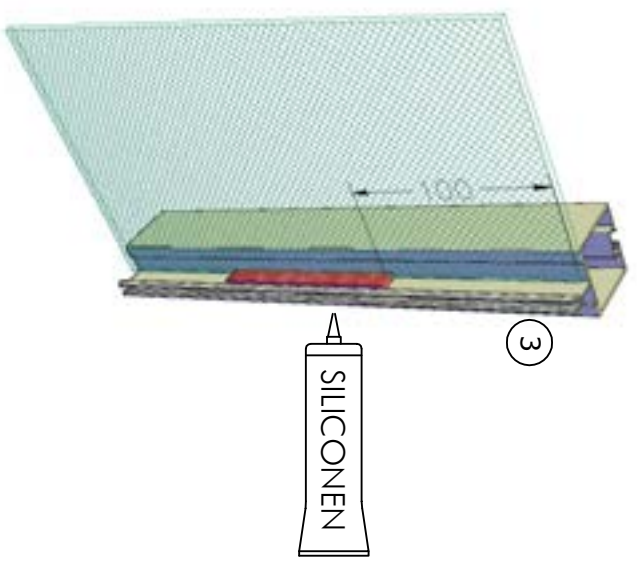
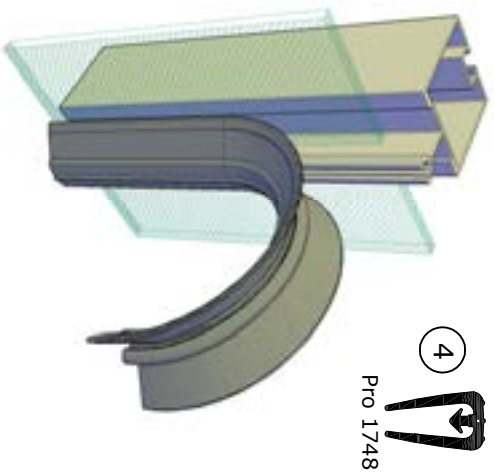
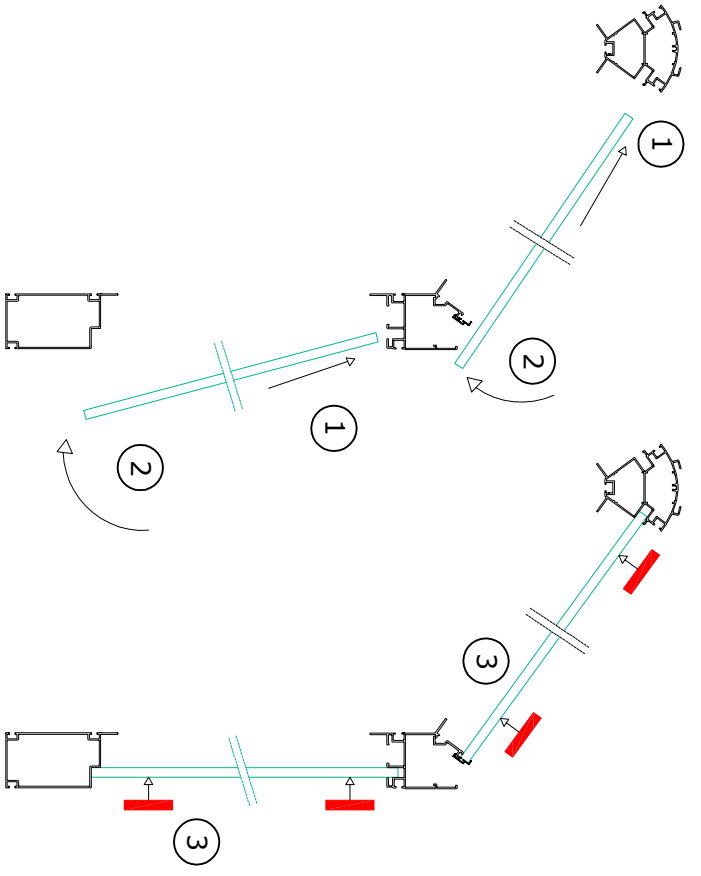

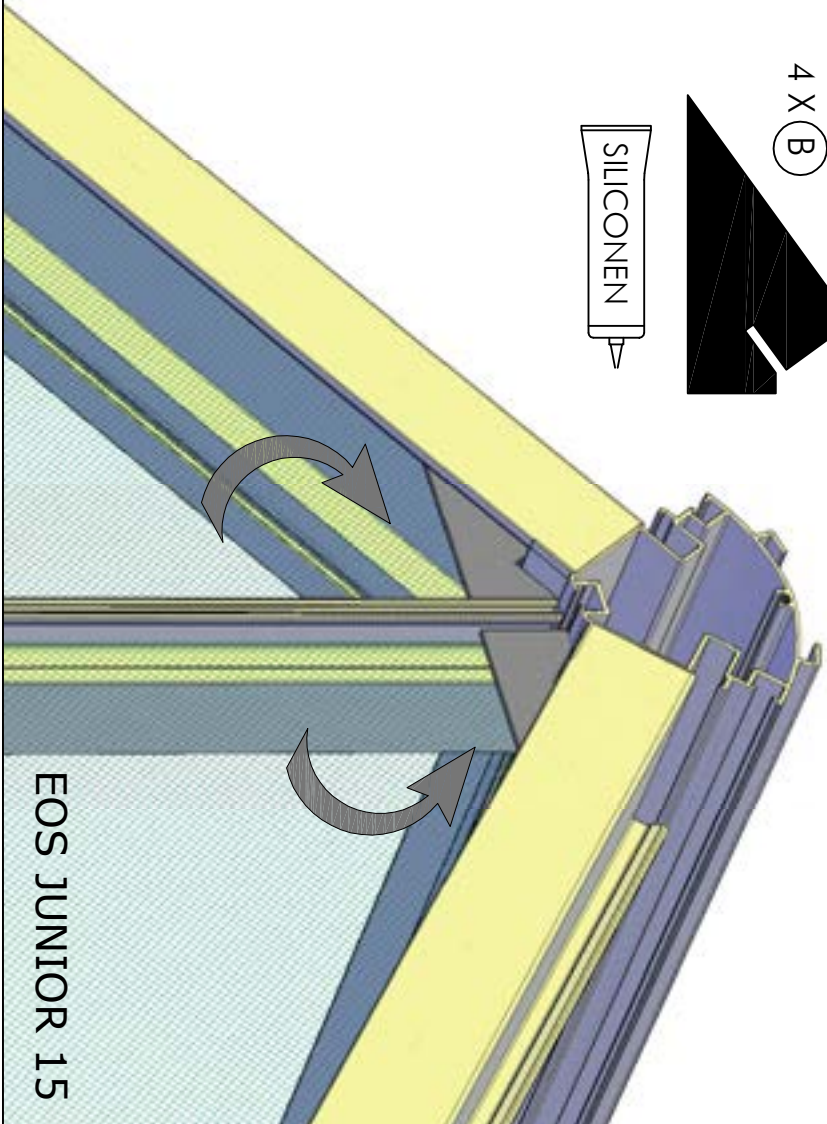
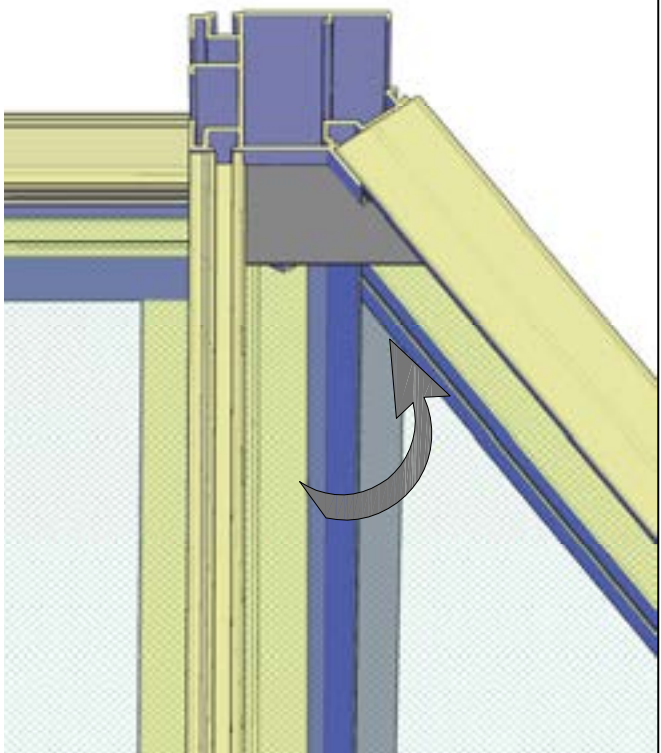
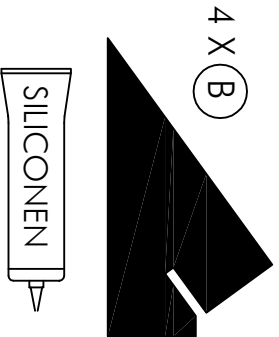
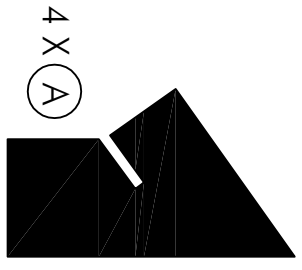
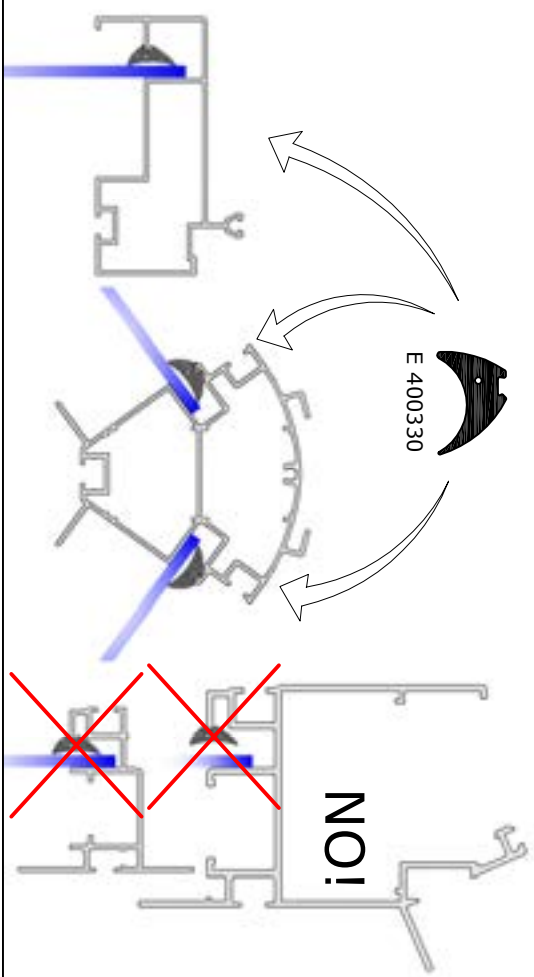
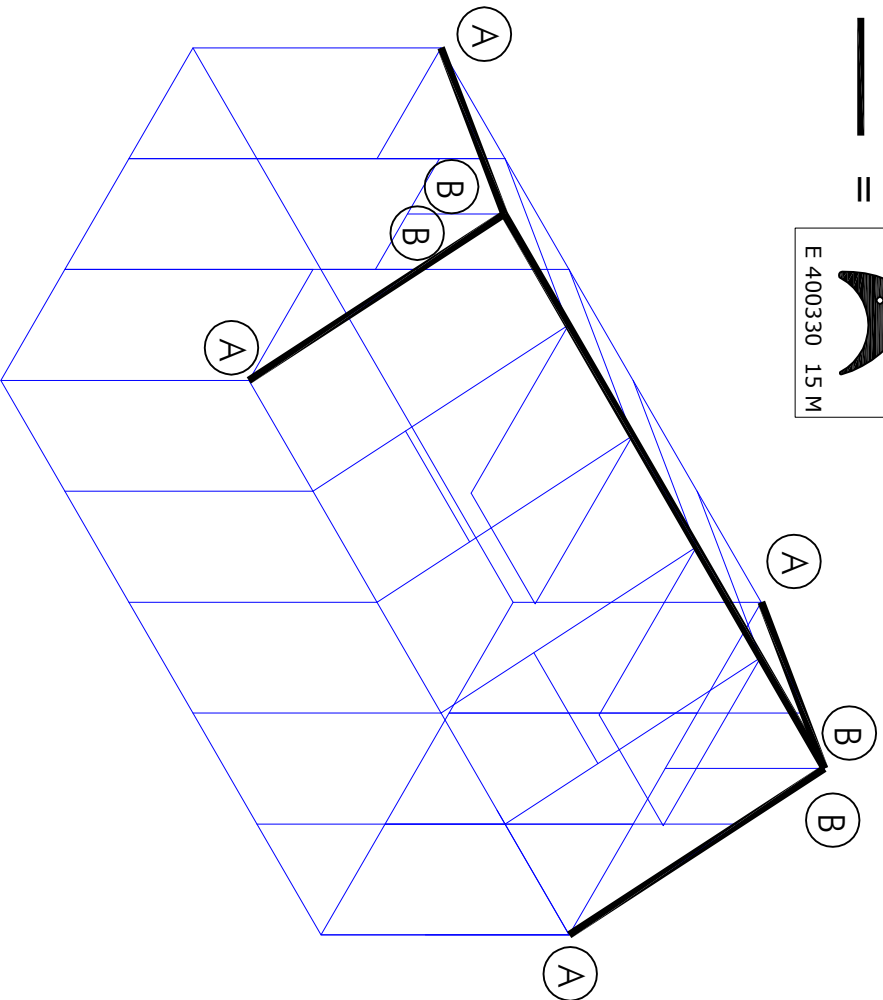

EOS JUNIOR 15

ACCESSOIRES / TOEBEHOREN

ACCESSOIRES

ACCESSORIES

ZUBEHOR

Schuifdeur-Porte Couliissante-Schiebetür-Sliding door
Skydedør-Skyvedør-Skuggväv-Porta scorrevole-Skjutdörr

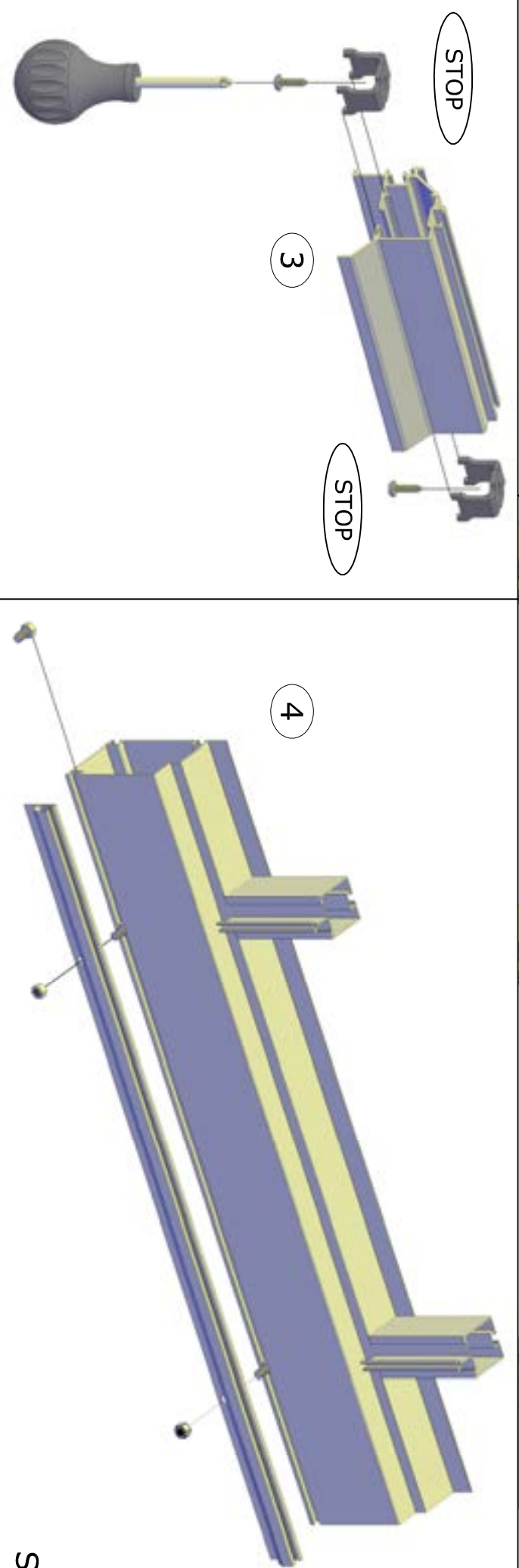
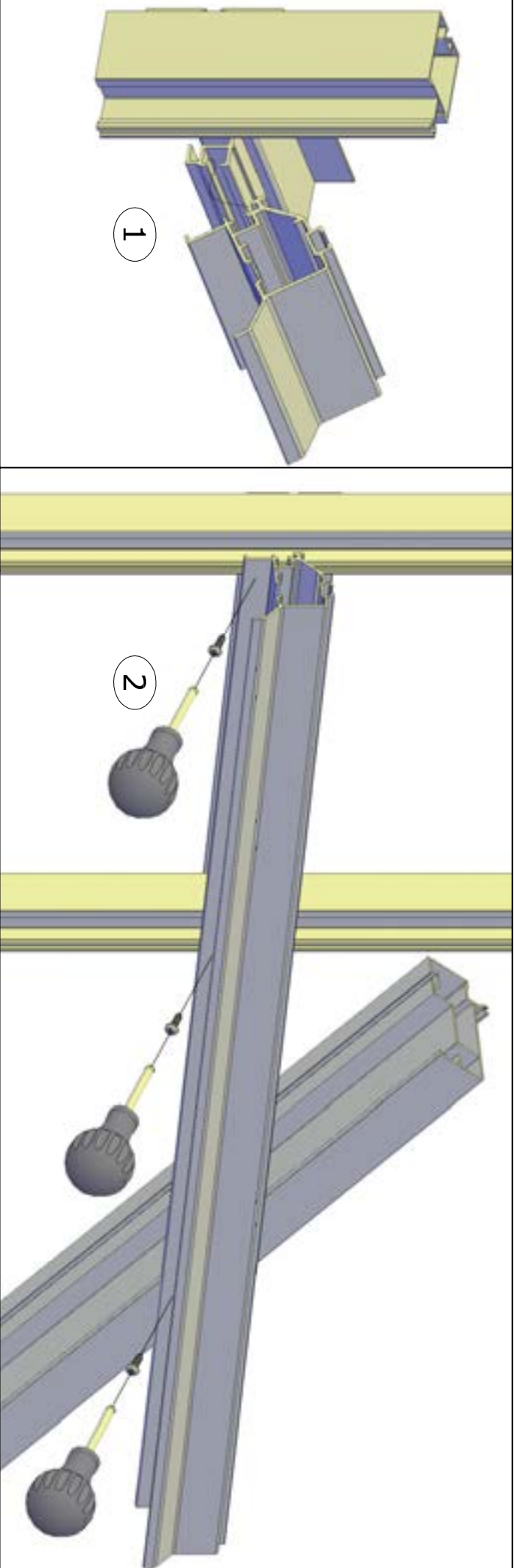

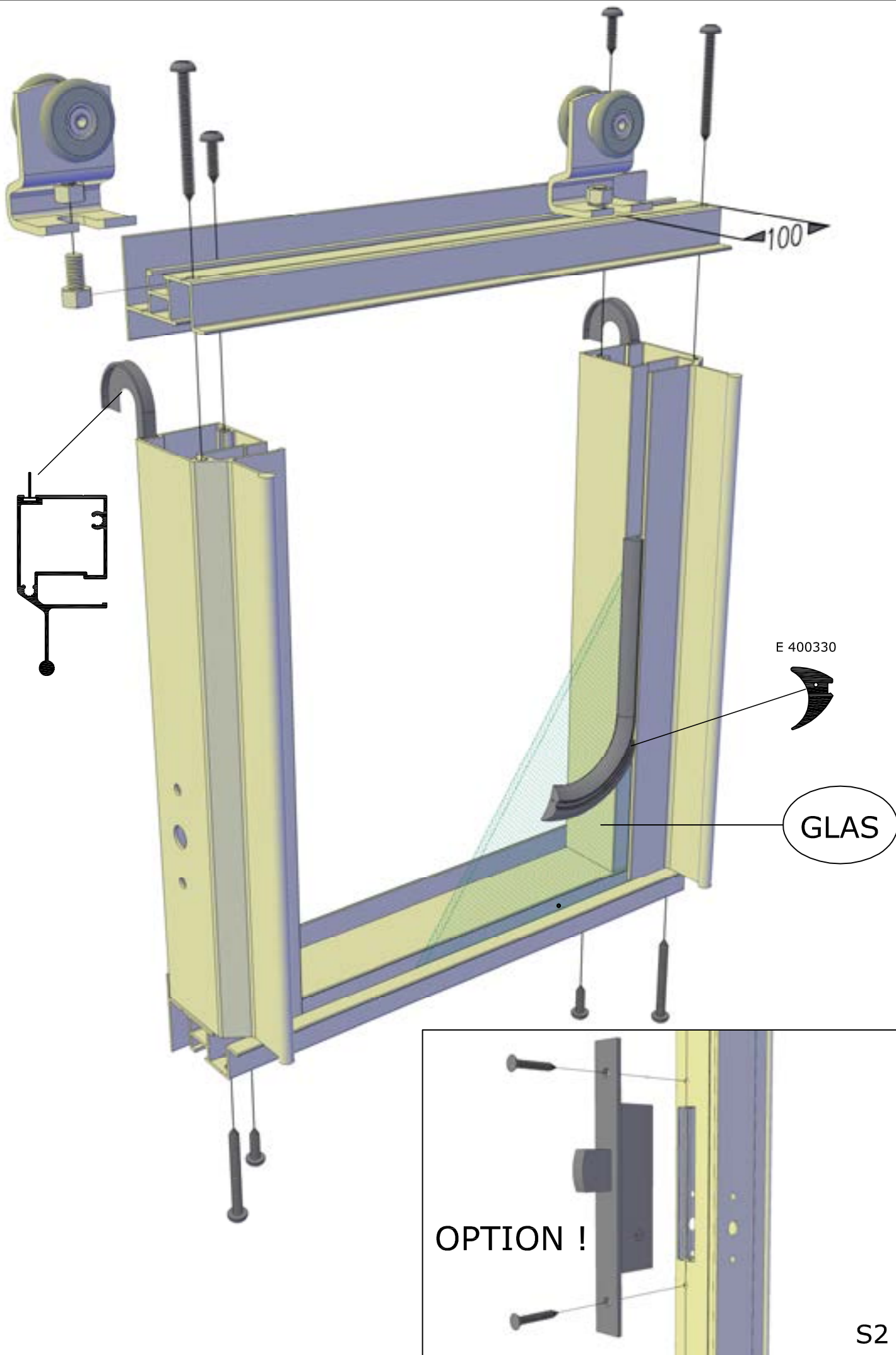

E 400330

GLAS

OPTION !

Dakraam-Lucarne-Dachfenster-Roofwindow-Tagvindue
Takluke-Takfönster-Finestra del tetto

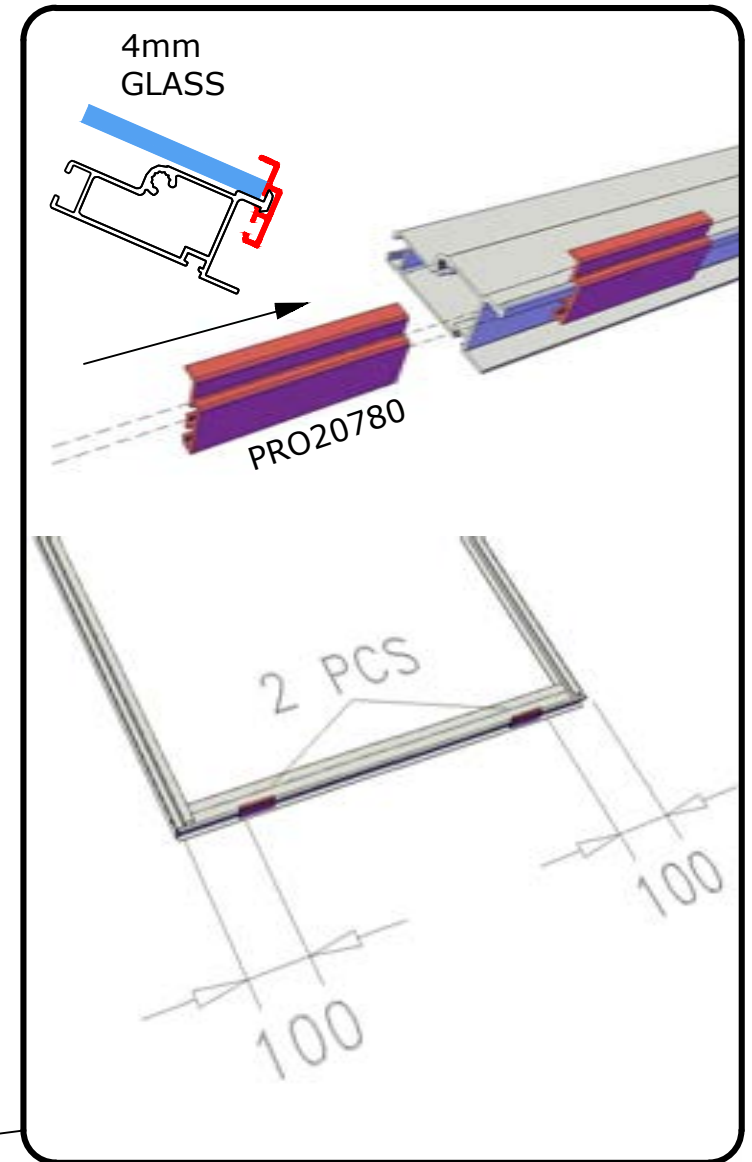
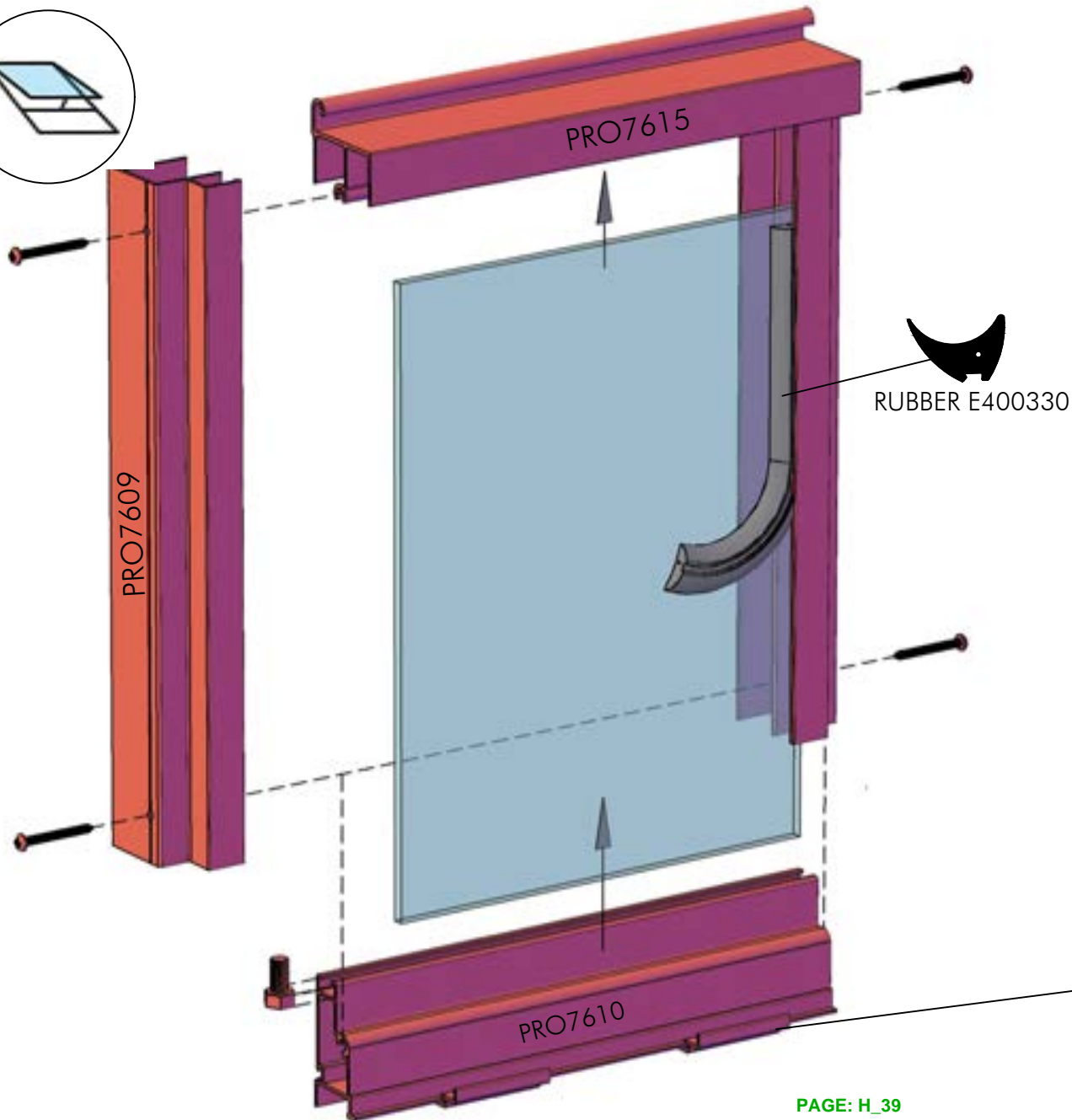

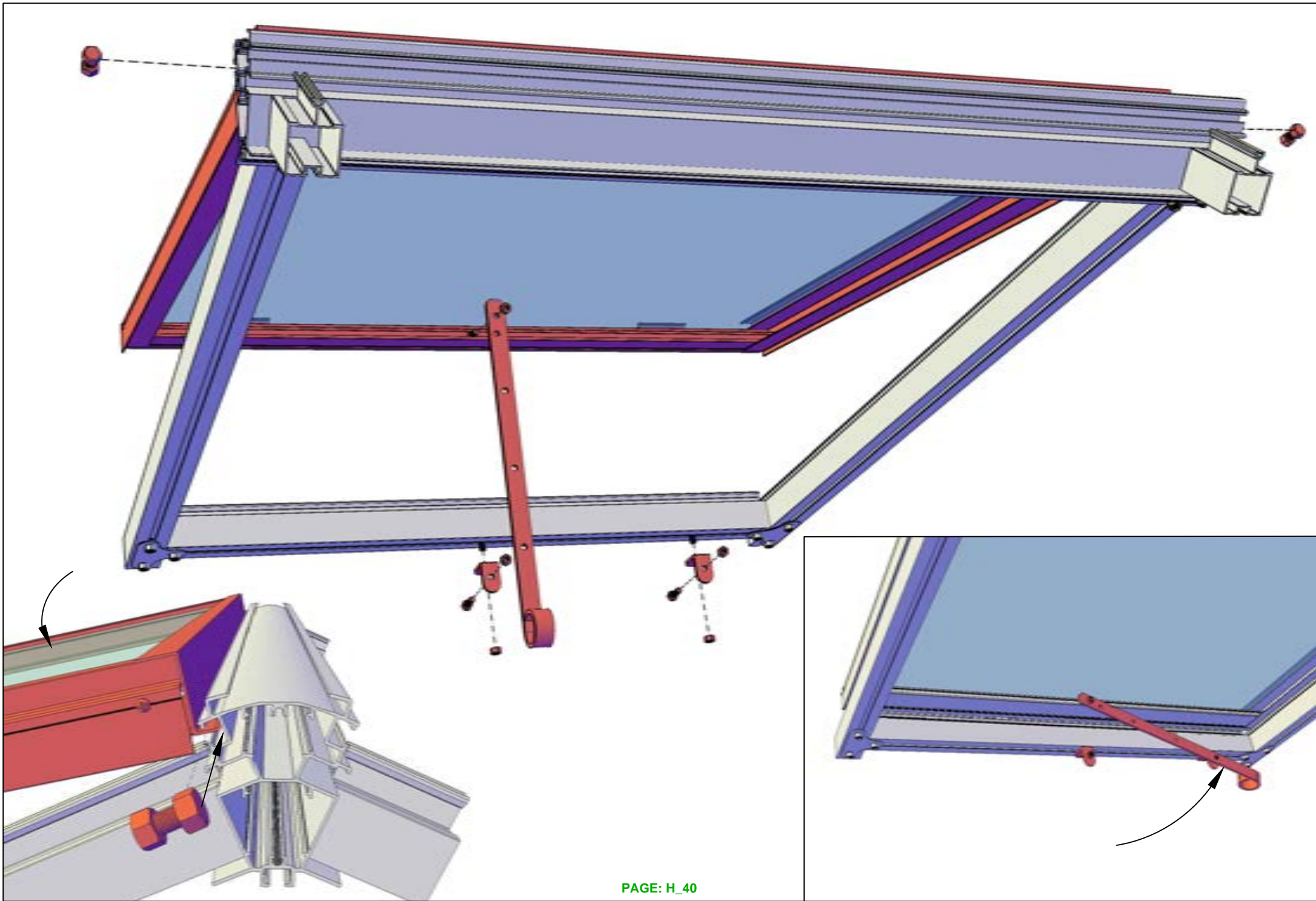

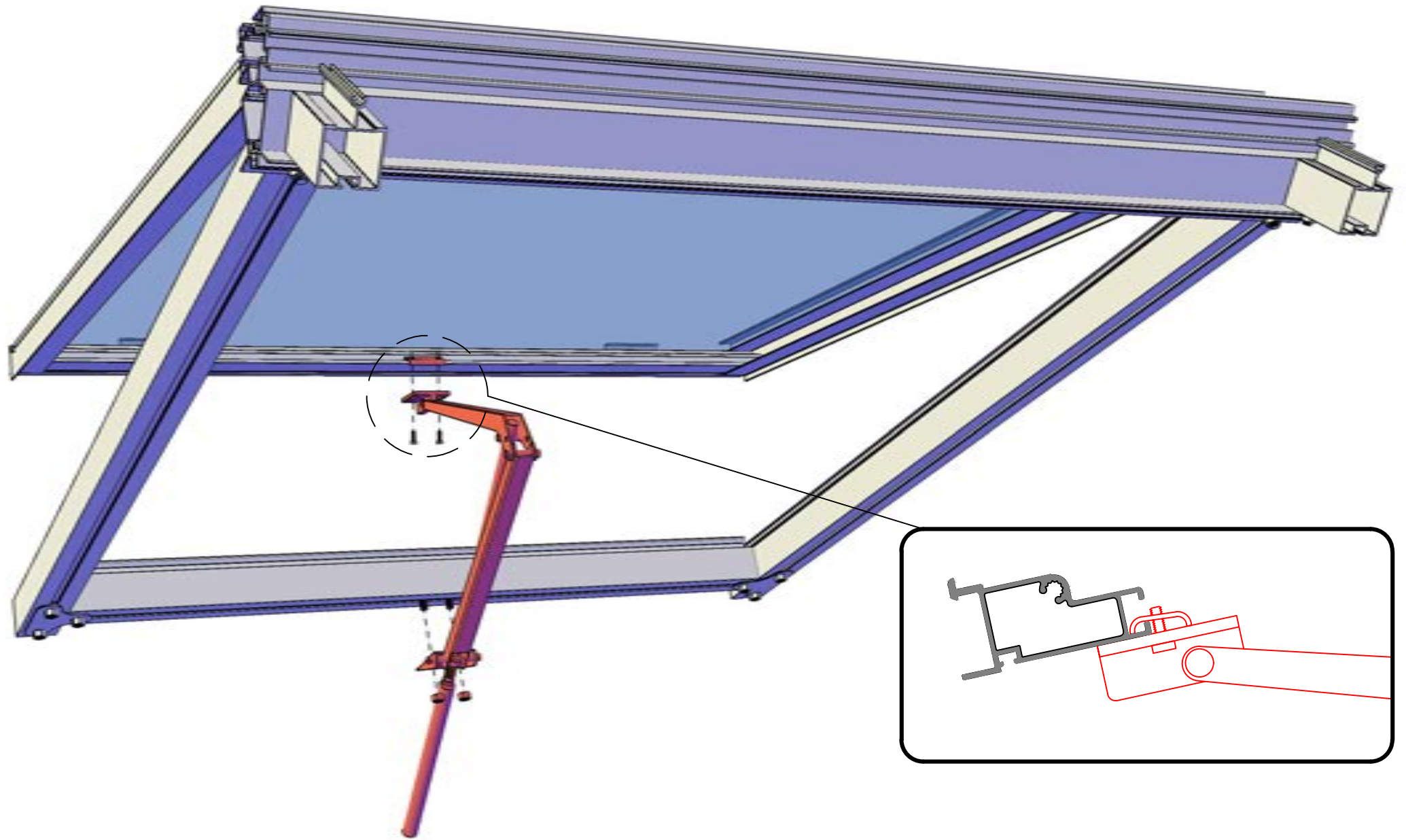

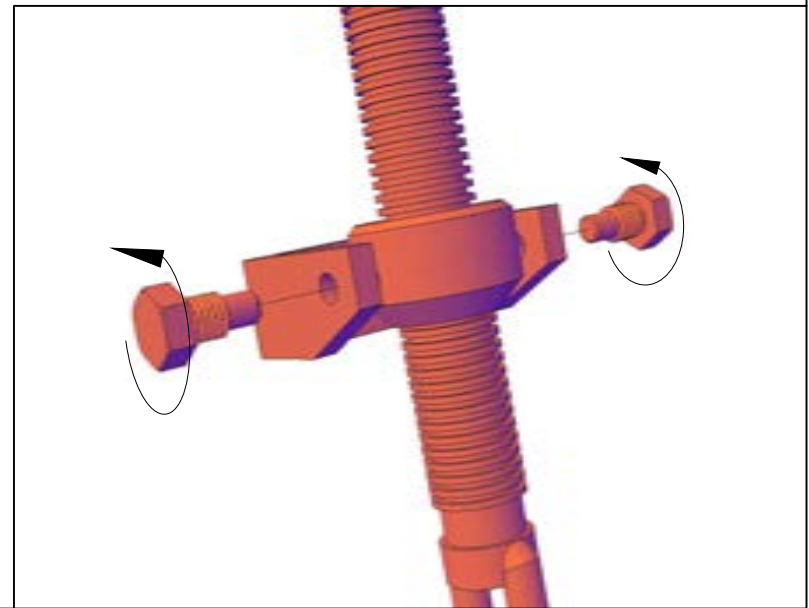
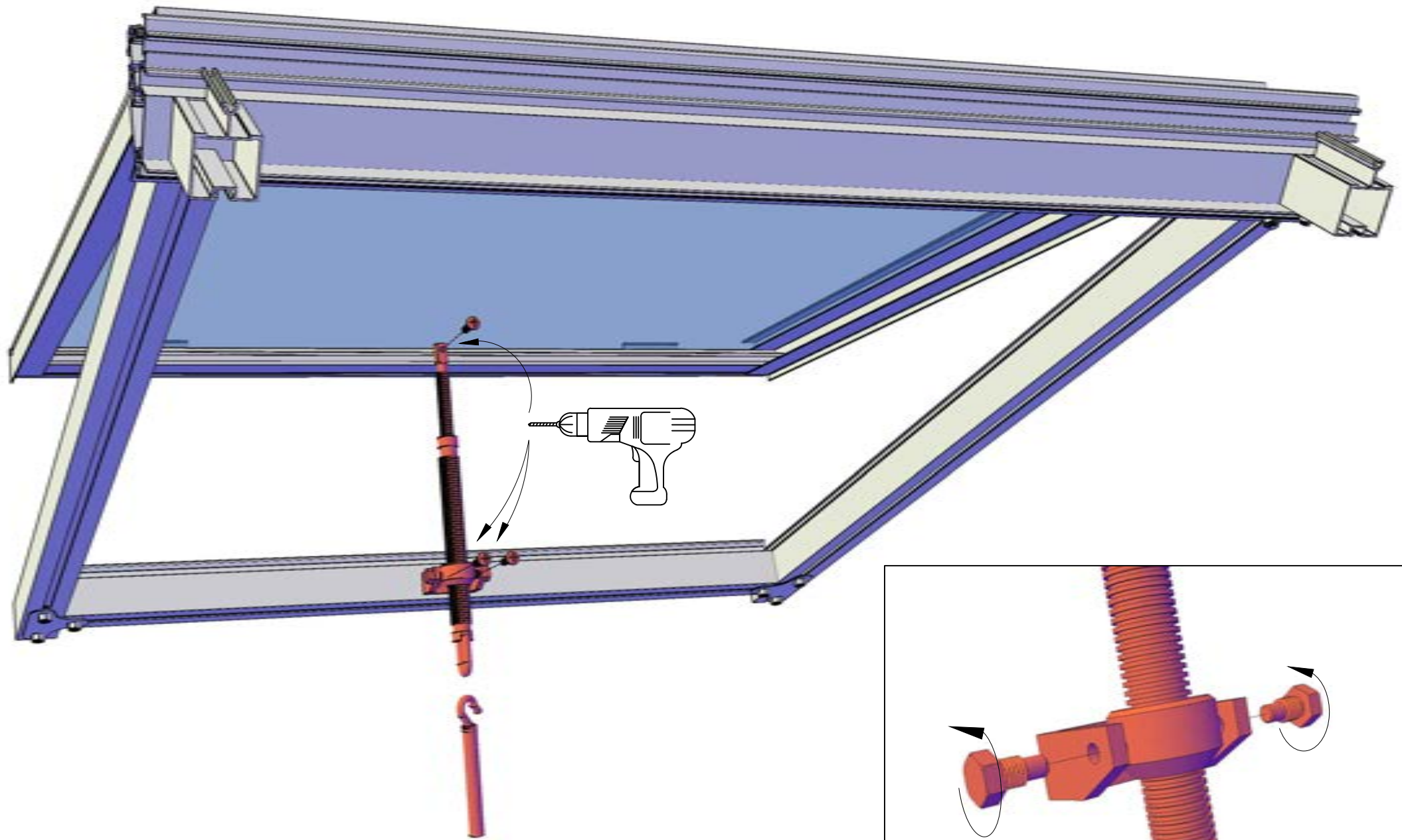

OPTION: STAGING TAB2

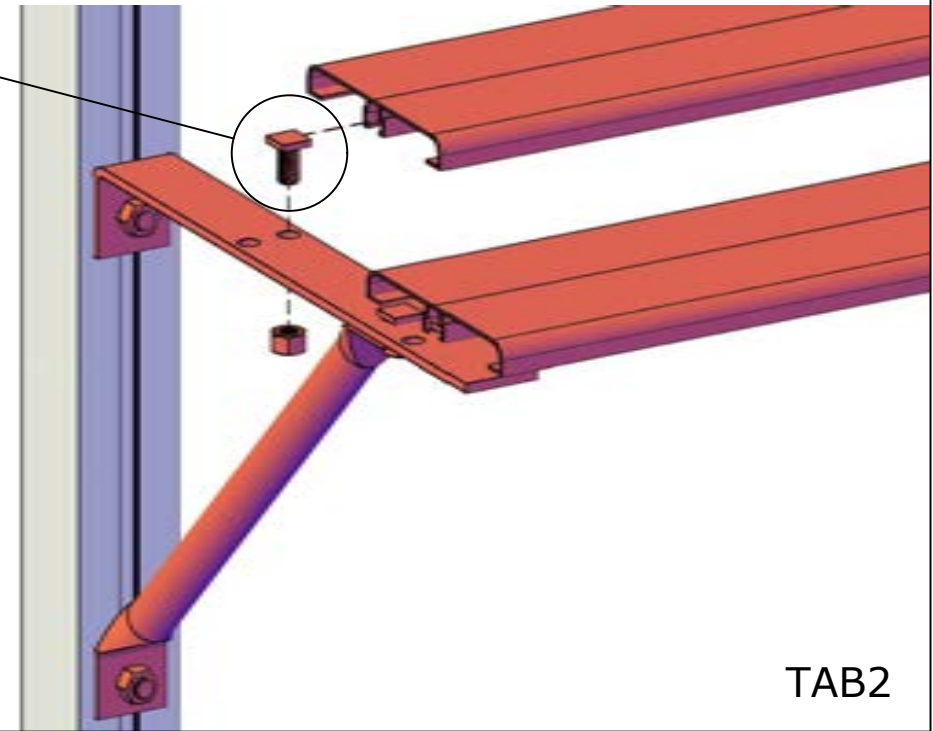
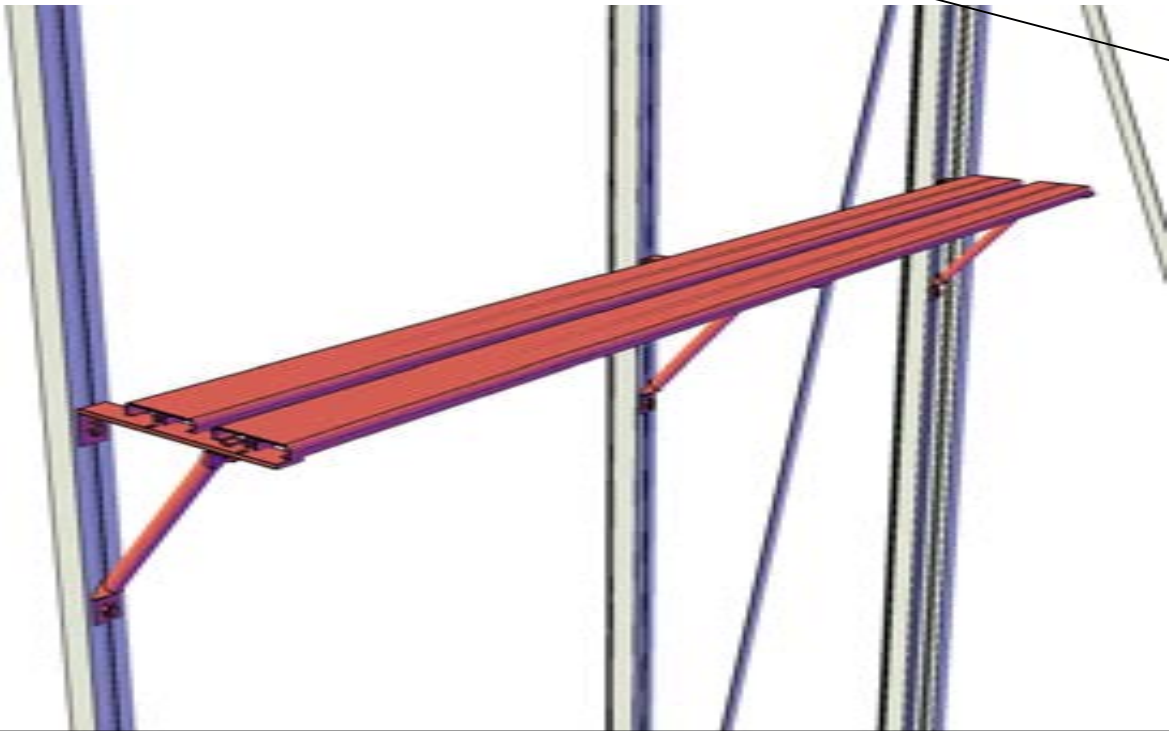
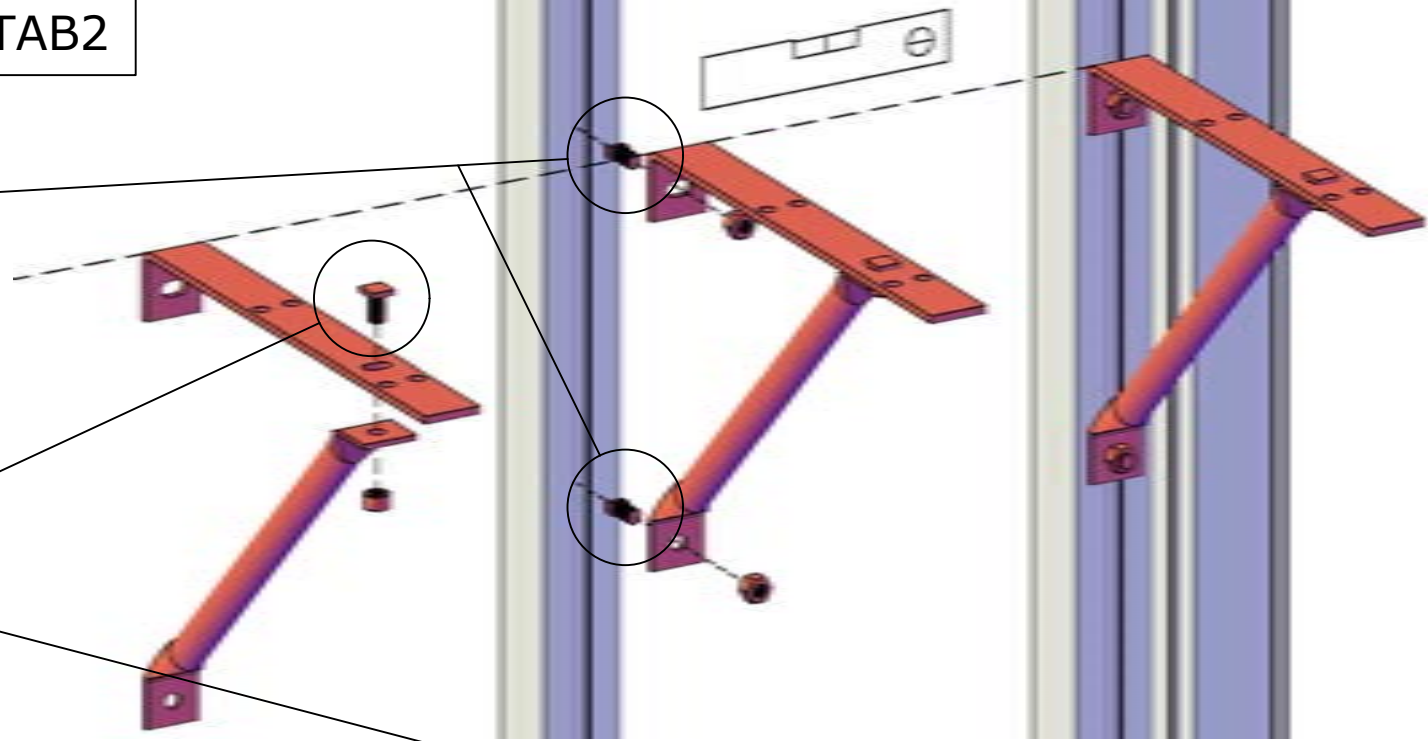
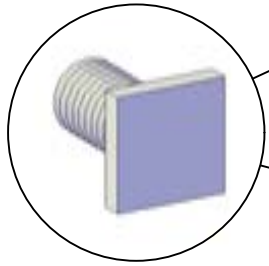
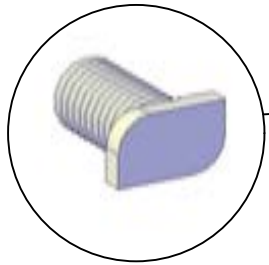

TAB2

OPTION: STAGING TAB5

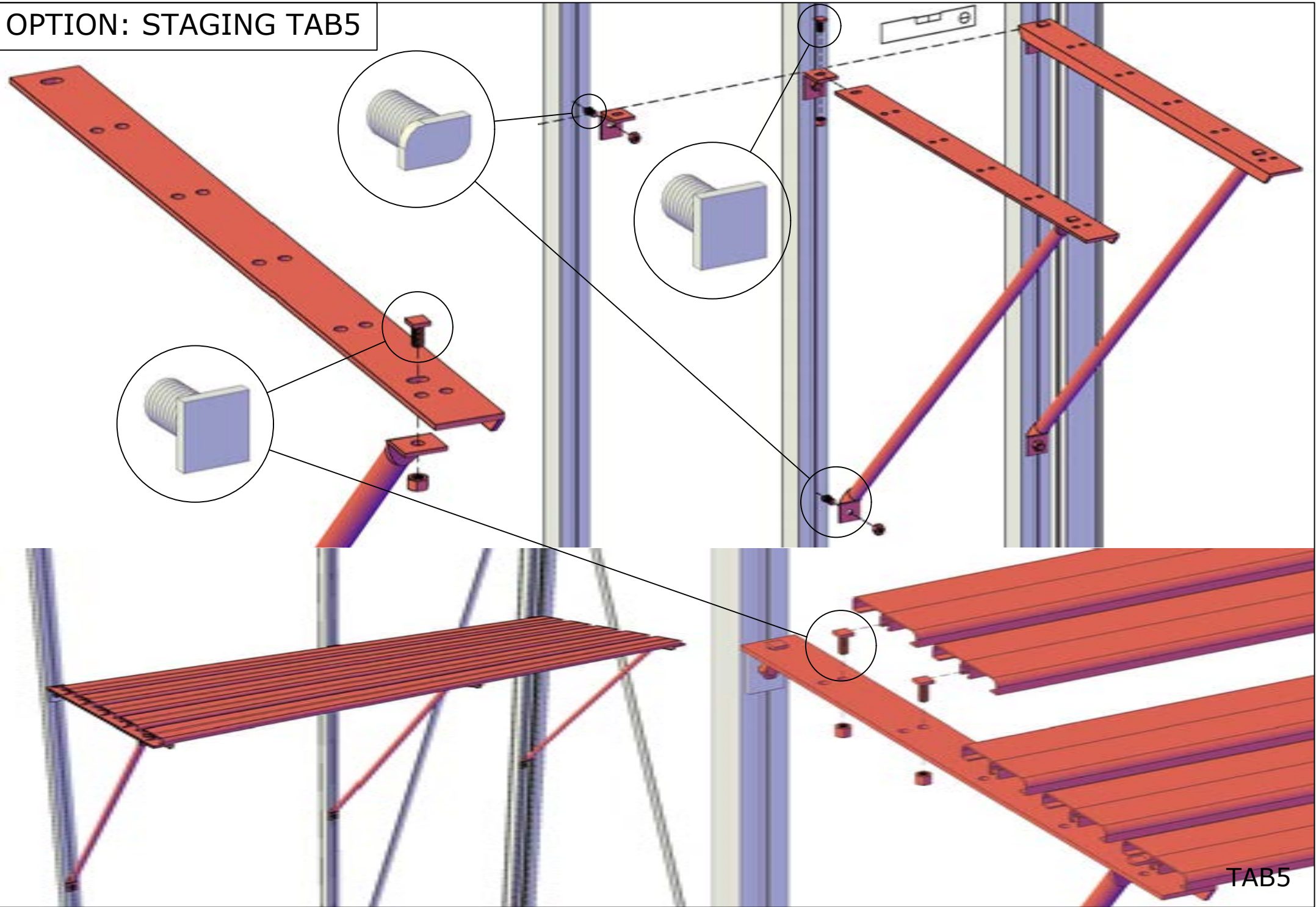

TAB5

OPTION: SHELF SH

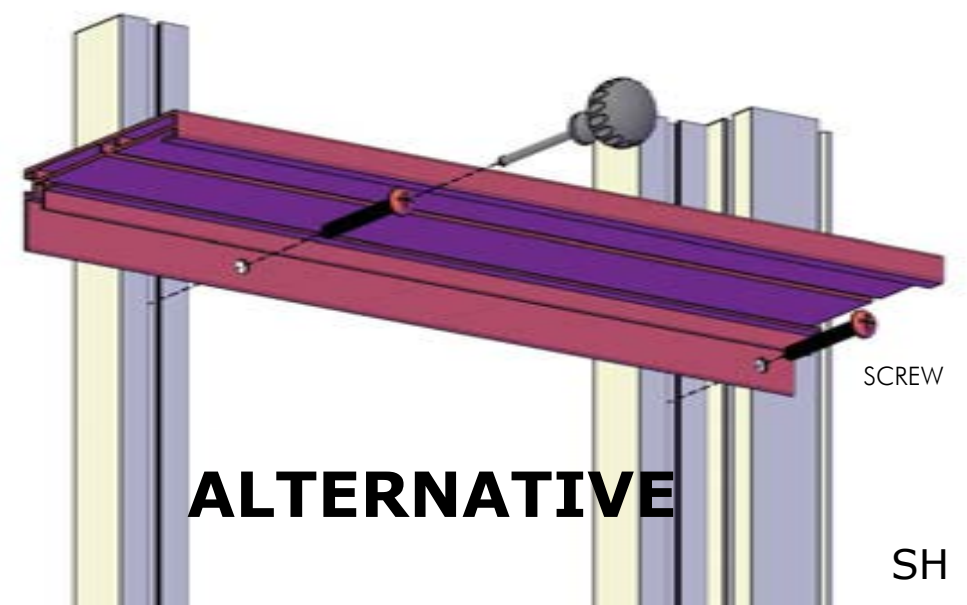
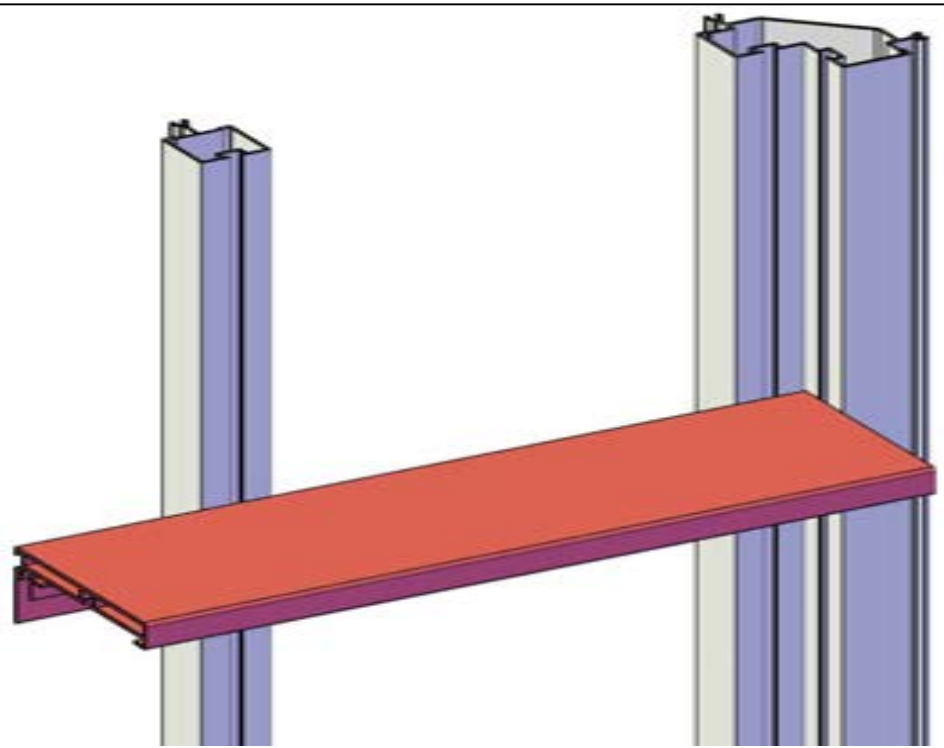
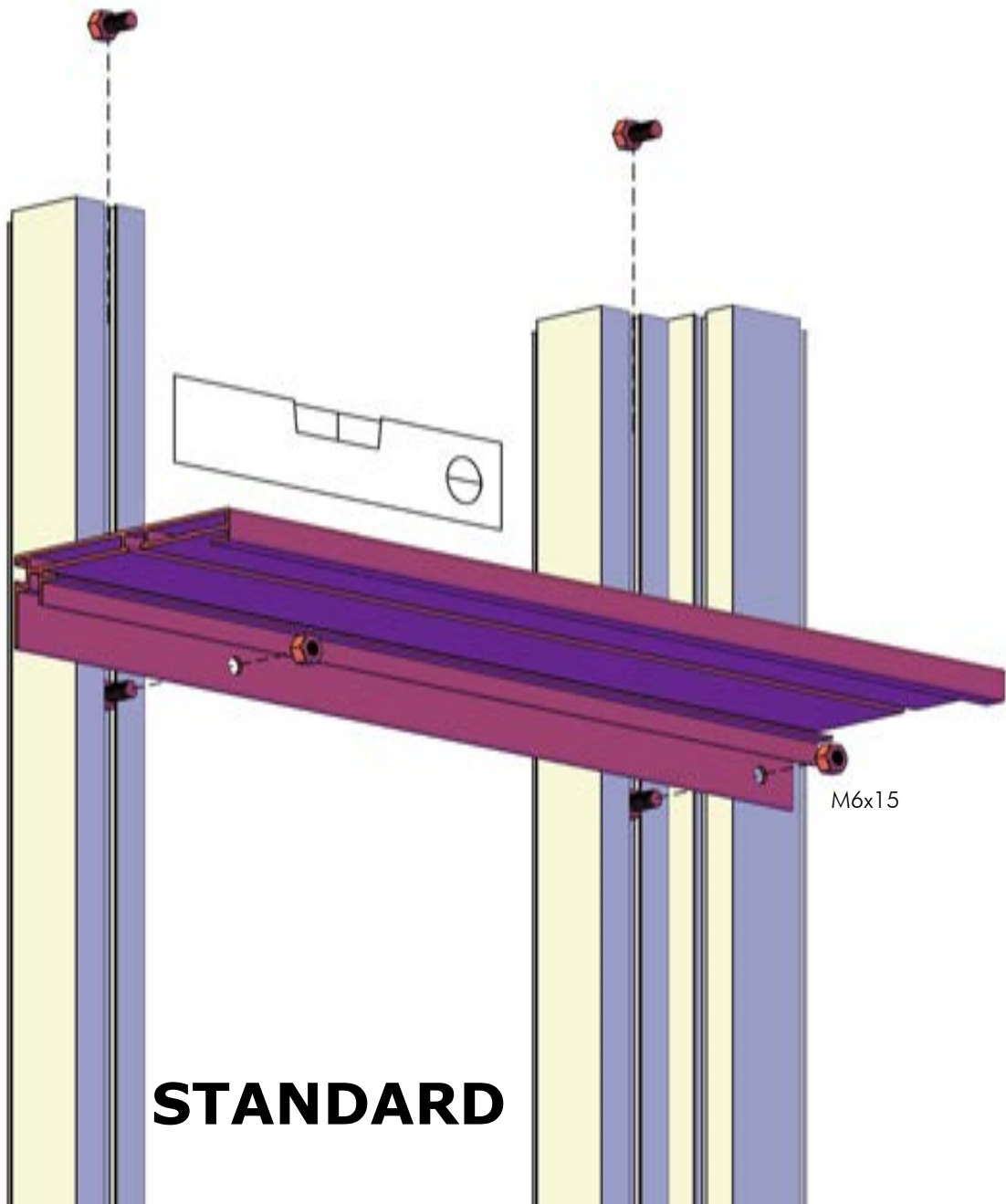

OPTION: SEEDBED ST

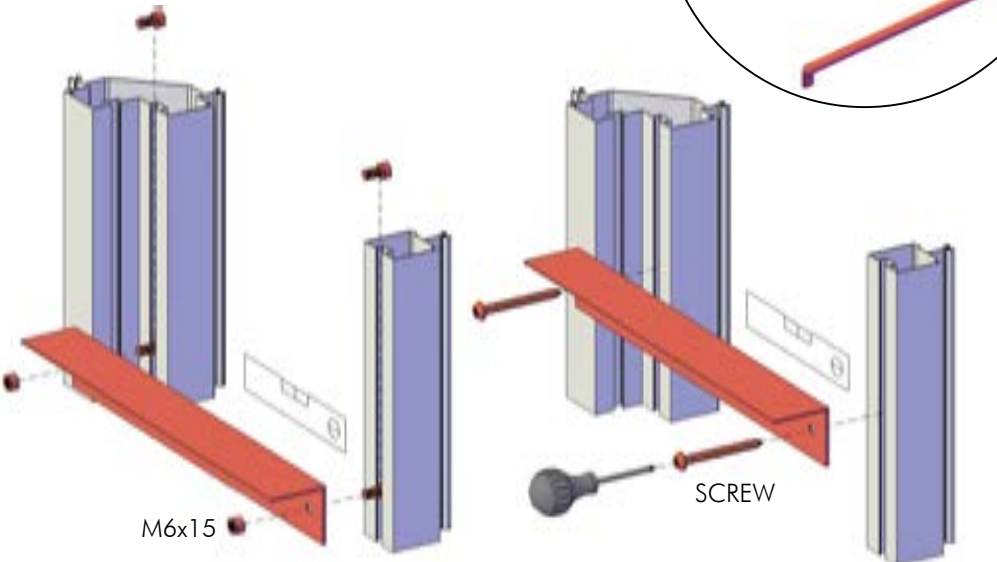
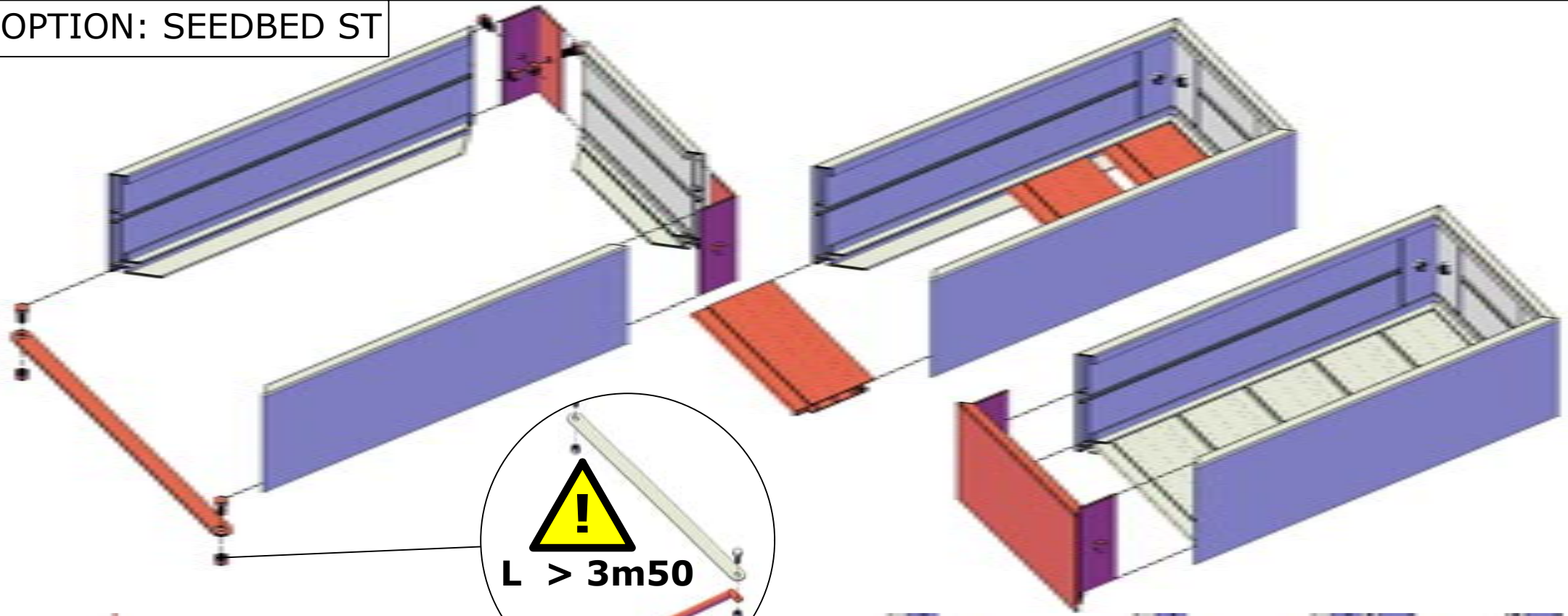

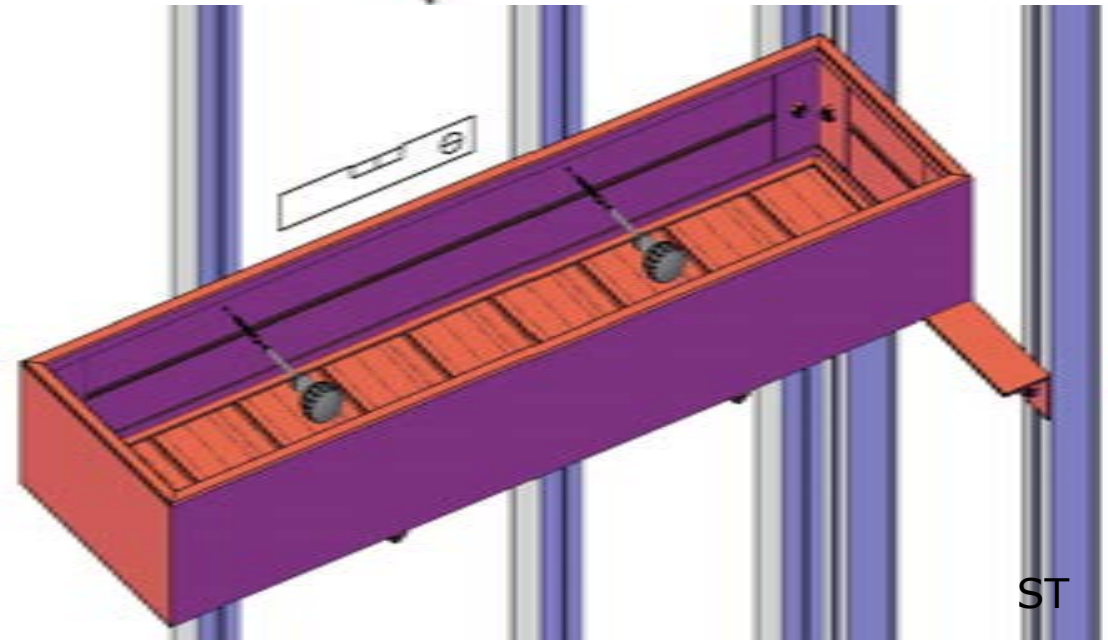

STANDARD

ALTERNATIVE



ST

Schermdoek - Toile d' ombrage - Strahlenschutz - Sunscreen
 Solskærm-Solskjerm-Telo ombregiante scorrevole - Skuggväv

TYPE	SUN236_73	SUN310_73	SUN236_300	SUN310_300
	24 pcs	24 pcs	93 pcs	93 pcs
	24 pcs	24 pcs	93 pcs	93 pcs

01

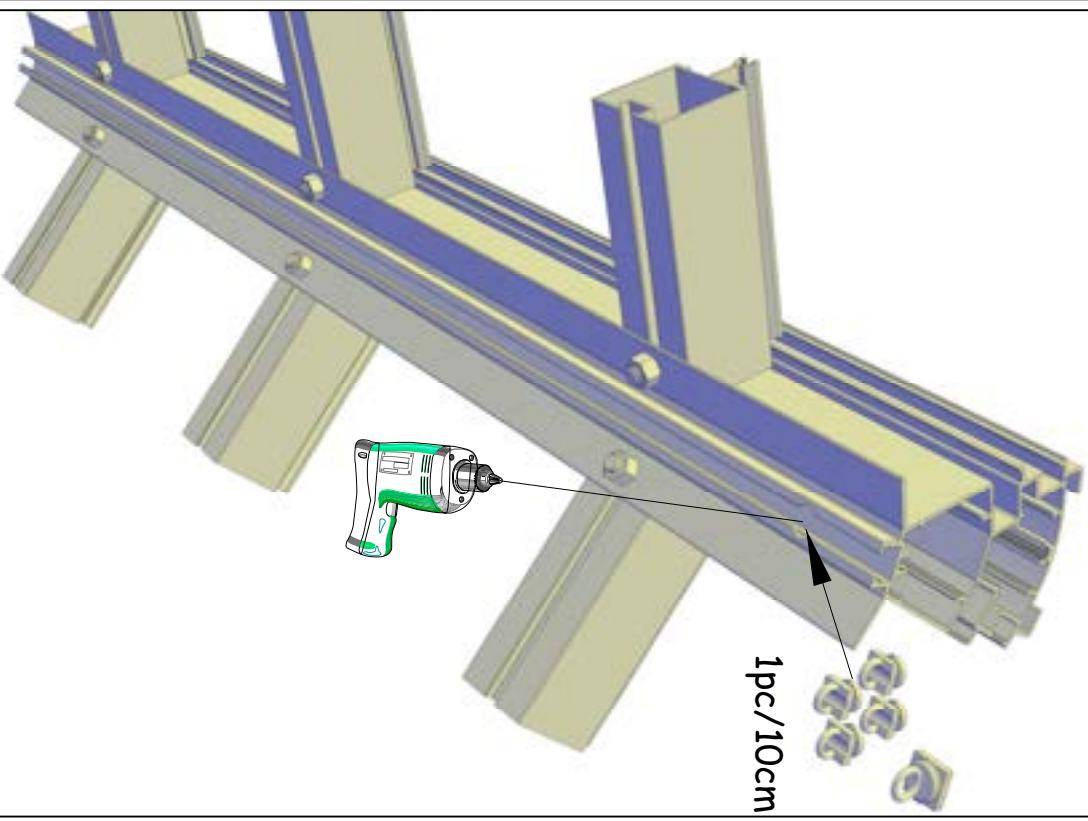

02

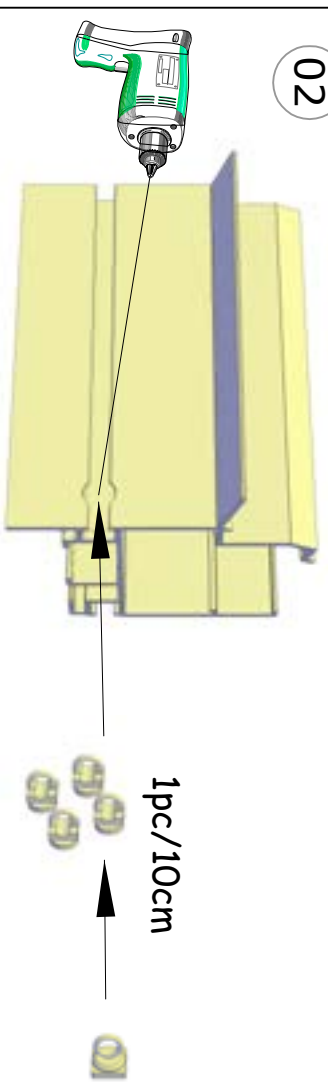

03

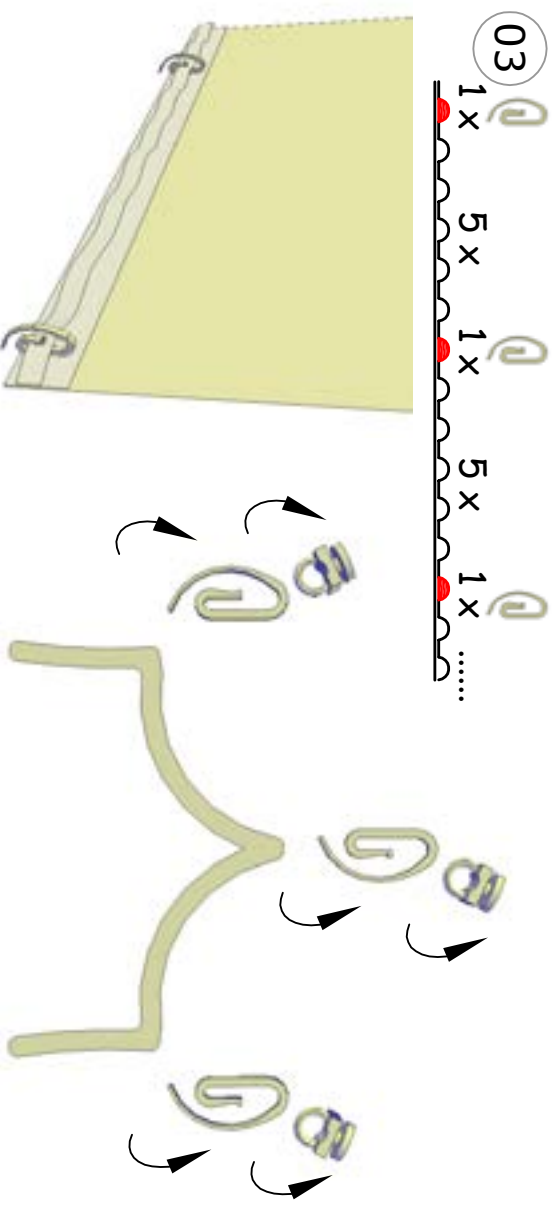

SD1

Janssens NV Mechelsesteenweg 388, B-2500 Lier Belgium
(T) +32 15 30 67 80 (W) www.janssens-alusystems.be (E) info@janssens-alusystems.be